

JVC

SERVICE MANUAL

STEREO RECEIVER

MODEL R-K100/R-K100L

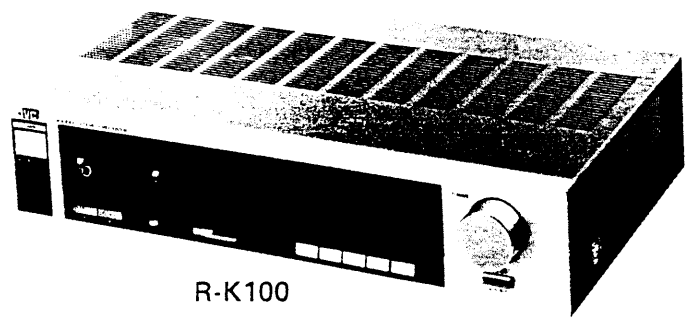

R-K100

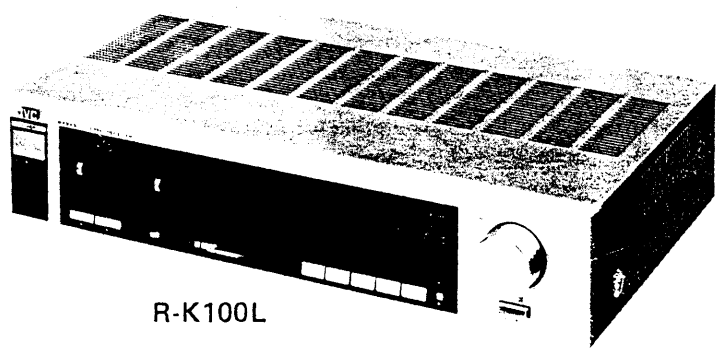

R-K100L

Contents

Safety Precautions	1-1	Parts List	Separate-volume Insertion
1. Specifications	1-2	5. R-K100/R-K100L Schematic Diagram	
2. Removal Procedures		5-(1) R-K100 Tuner Section	1-6
2-(1) Removing the Bottom Cover	1-3	5-(2) R-K100(G) Tuner Section	
2-(2) Removing the Power Amplifier		(for West Germany only)	1-7
(STK4141II)	1-3	5-(3) R-K100L Tuner Section	1-8
2-(3) Removing the Dial Pointer	1-3	5-(4) R-K100/R-K100L Amplifier Section	1-9
3. Dial Stringing Procedure	1-4	6. Servicing method for AWG #20 wires with	
4. FM/MW (LW) Tuner Alignment Procedures	1-5	clamping terminals	1-10
4-(1) FM Section	1-5		
4-(2) MW (LW) Section	1-5		

Safety Precautions

- The design of this product contains special hardware, many circuits and components specially for safety purposes. For continued protection, no changes should be made to the original design unless authorized in writing by the manufacturer. Replacement parts must be identical to those used in the original circuits. Service should be performed by qualified personnel only.
- Alterations of the design or circuitry of the product should not be made. Any design alterations or additions will void the manufacturer's warranty and will further relieve the manufacturer of responsibility for personal injury or property damage resulting therefrom.
- Many electrical and mechanical parts in the product have special safety-related characteristics. These characteristics are often not evident from visual inspection nor can the protection afforded by them necessarily be obtained by using replacement components rated for higher voltage, wattage, etc. Replacement parts which have these special safety characteristics are identified in the parts list of Service manual. Electrical components having such features are identified by shading on the schematics and by (Δ) on the parts list in Service manual. The use of a substitute replacement which does not have the same safety characteristics as the recommended replacement part shown in the parts list in Service manual may create shock, fire, or other hazards.
- The leads in the products are routed and dressed with ties, clamps, tubings, barriers and/or the like to be separated from live parts, high temperature parts, moving parts and/or sharp edges for the prevention of electric shock and fire hazard. When service is required, the original lead routing and dress should be observed, and they should be confirmed to be returned to normal, after re-assembling.

5. Leakage current check

(Safety for electrical shock hazard)

After re-assembling the product, always perform an isolation check on the exposed metal parts of the Products (antenna terminals, knobs, metal cabinet, screw heads, earphone jack, control shafts, etc.) to be sure the product is safe to operate without danger of electrical shock.

Do not use a line isolation transformer during this check.

- Plug the AC line cord directly into the AC outlet. Using a "Leakage Current Tester", measure the leakage current from each exposed metal part of the cabinet, particularly any exposed metal part having a return path to the chassis, to a known good earth ground (water pipe, etc.). Any leakage current must not exceed 0.5 mA AC (r.m.s.).

- Alternate check method.

Plug the AC line cord directly into the AC outlet. Use an AC voltmeter having 1,000 ohms per volt or more sensitivity in the following manner. Connect a 1500 Ω 10 W resistor paralleled by a 0.15 μ F AC-type capacitor between an exposed metal part and a known good earth ground (water pipe, etc.).

Measure the AC voltage across the resistor with the AC voltmeter.

Move the resistor connection to each exposed metal part, particularly any exposed metal part having a return path to the chassis, and measure the AC voltage across the resistor. Now, reverse the plug in the AC outlet and repeat each measurement. Any voltage measured must not exceed 0.75 V AC (r.m.s.). This corresponds to 0.5 mA AC (r.m.s.).

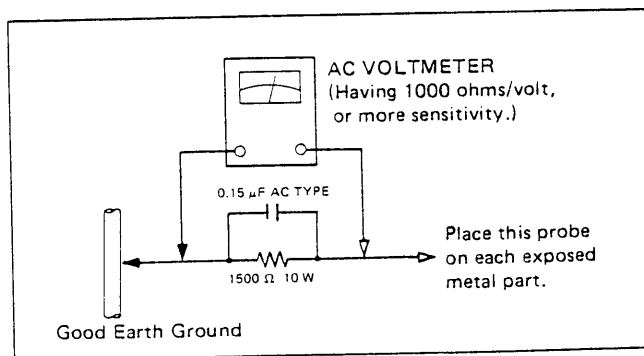

CHECKING YOUR LINE VOLTAGE (Except for U.S.A., Canada, Australia, U.K. and Continental Europe.)

Before inserting the power plug, please check this setting to see that it corresponds with the line voltage in your area. If it doesn't, be sure to adjust the voltage selector switch to the proper setting before operating this equipment. The voltage selector switch is located on the rear panel.

CAUTION Before selecting the "Voltage selector switch" to proper voltage disconnect the power plug.

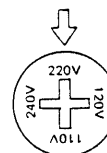

1. Specifications

FM TUNER SECTION

	'78 IHF	DIN (for Europe)
Tuning Range	: 88 MHz – 108.0 MHz	87.5 MHz-108.0 MHz
Usable Sensitivity	: Mono 10.8 dBf 0.95 μ V/75 ohms 1.9 μ V/300 ohms	(S/N 26 dB) 1.5 μ V/75 ohms 3 μ V/300 ohms
50 dB Quieting Sensitivity	: Mono 17.3 dBf (4.0 μ V/300 ohms) Stereo 38.3 dBf (45 μ V/300 ohms)	—
S/N 46 dB Stereo Sensitivity	: —	Stereo 30 μ V /75 ohms Stereo 60 μ V/300 ohms
Signal to Noise Ratio	: Mono 76 dB Stereo 70 dB (A-net)	Mono 70 dB Stereo 63 dB (weighted)
Total Harmonic Distortion 1kHz	: Mono 0.15 % Stereo 0.3 %	—
Frequency Response	: 30 Hz – 12.5 kHz, +0.5 dB – 3 dB	—
Capture Ratio	: 1.5 dB	1.0 dB
Alternate Channel Selectivity	: 60 dB \pm 400 kHz	55 dB \pm 300 kHz
Image Response Ratio	: 55 dB at 98 MHz	—
IF Response Ratio	: 85 dB at 98 MHz	—
Stereo Separation	: 40 dB at 1 kHz	—

MW Tuner Section

Tuning Range	: 525 kHz – 1605 kHz
Usable Sensitivity (at 1000 kHz)	: 300 μ V/m, 50 μ V (External Antenna)
Signal to Noise Ratio	: 50 dB
Distortion	: 0.5 % at 100 mV/m
Selectivity	: 23 dB, \pm 10 kHz 20 dB, \pm 9 kHz

LW Tuner Section

Tuning range	: 150 kHz – 350 kHz
Usable Sensitivity	: 400 μ V/m, 70 μ V (External Antenna)
Signal to Noise Ratio	: 50 dB at 245 kHz 100 mV/m
Distortion	: 0.5 % at 245 kHz 100 mV/m
Selectivity	: 30 dB, \pm 9 kHz at 245 kHz

Amplifier Section

RMS Power : 25 watts per channel min. RMS, both channels driven, into 8 ohms from 40 Hz to 20 kHz, with no more than 0.5 % total harmonic distortion.

Input Sensitivity/Impedance		
PHONO	: 2.5 mV/47 kohms	
TAPE PLAY/DAD/AUX	: 140 mV/40 kohms	
Recording Output level	: 140 mV	
Frequency Response		
PHONO (RIAA Equalization)	: 20 Hz – 20 kHz, +1 dB, -1 dB	
TAPE PLAY/DAD/AUX	: 15 Hz – 40 kHz, +1 dB, -1 dB	
Tone Control		
Bass	: \pm 8 dB at 100 Hz	
Treble	: \pm 8 dB at 10 kHz	
Signal to Noise Ratio		
PHONO	: 70 dB ('66 IHF) 78 dB ('78 IHF) (Rec out)	59 dB (DIN)
TAPE PLAY/DAD/AUX	: 91 dB ('66 IHF), 74 dB ('78 IHF)	64 dB (DIN)

Power Specifications

Areas	Line Voltage & Frequency	Power Consumption
U.S.A. & Canada	AC 120 V, 60 Hz	100 watts, 130 VA
Continental Europe	AC 220 V \sim , 50 Hz	80 watts
U.K. & Australia	AC 240 V \sim , 50 Hz	80 watts
Other Areas	AC 110/120/220/240 V \sim , Selectable, 50/60 Hz	80 watts

Dimensions and Weight

Dimensions			Weight
Height	Width	Depth	Net
92 mm (3-5/8")	435 mm (17-1/8")	303 mm (11-15/16")	4.6 kg (10.1 lbs)

PARTS LIST

Contents

1. Main Parts Locations	2-2
2. Exploded View and Part Numbers	2-3
3. Printed Circuit Board Ass'y and Parts List	2-6
3-(1) ENA-021 Tuner P.C. Board Ass'y	2-6
3-(2) ENH-026 Amplifier P.C. Board Ass'y	2-10
4. Packing Materials and Part Numbers	2-13
5. Label	2-14
6. Accessories List	2-14

1. Main Parts Locations

1-(1) Top View

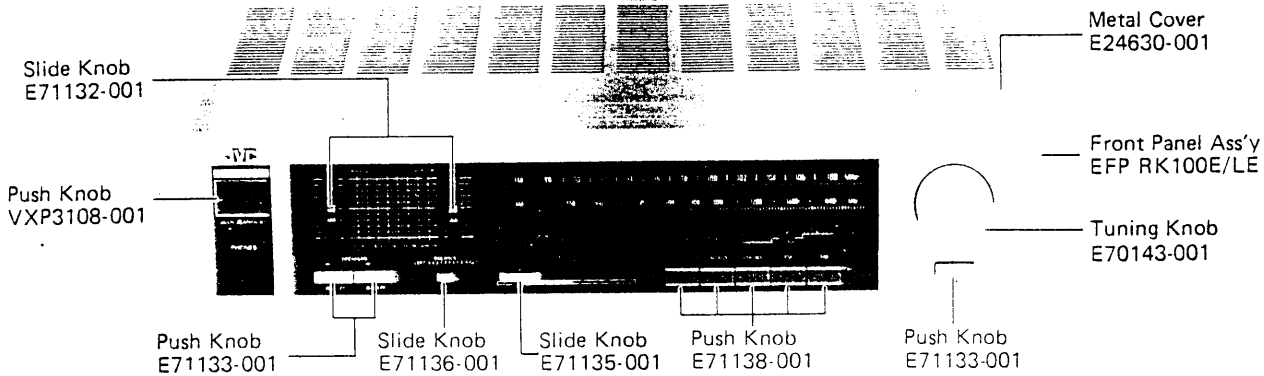

1-(2) Front View

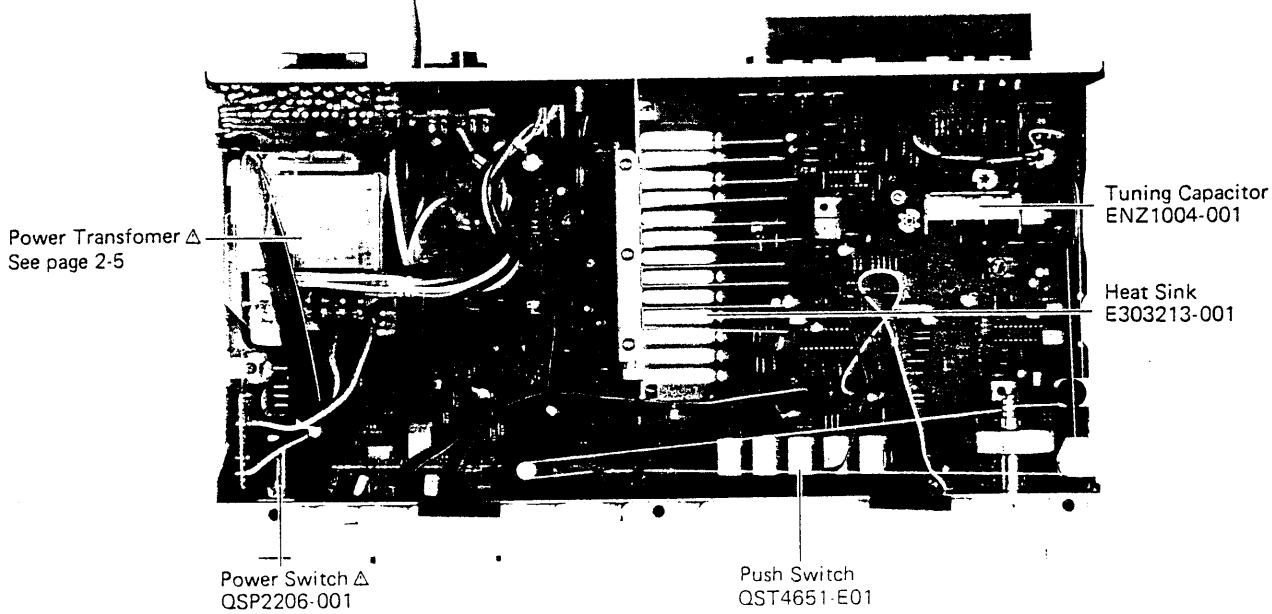

1-(3) Rear View

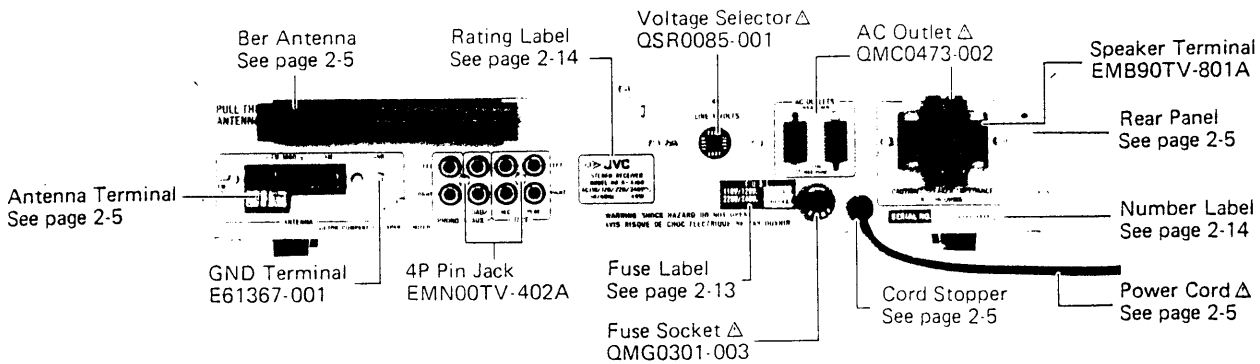

2. Exploded View and Part Numbers

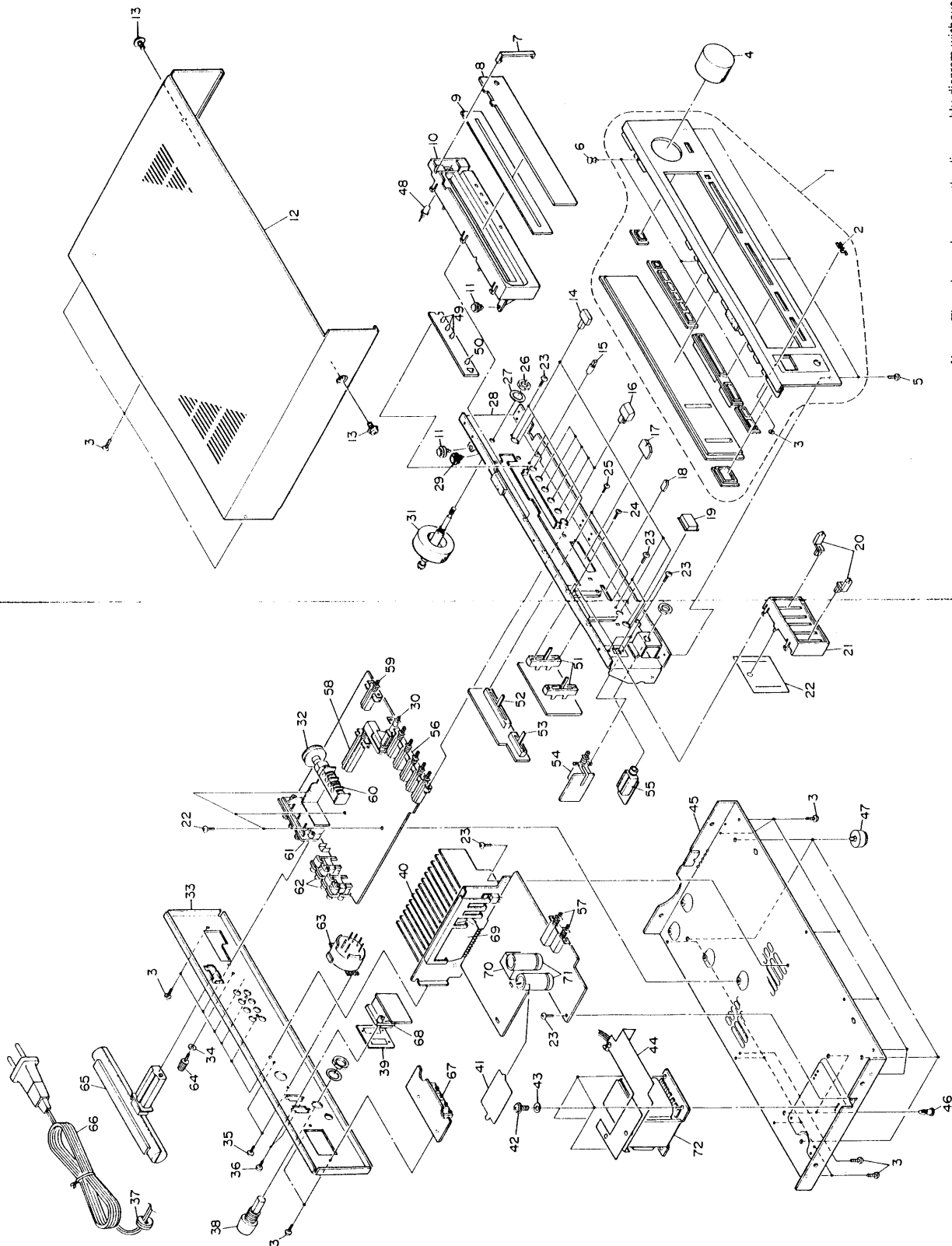

Note: Those items shown on the disassembly diagram without indication of reference Nos. are supplied as assembly parts.

Fig. 1
(No. 2729) 2.3

No.	Part Number	Part Name	Q'ty	Description	Area
1	EFP-RK100E	Front Panel Ass'y	1		J,C,U,P,PG,E,A,G
2	EFP-RK100LE	Front Panel Ass'y	1		LE,LBS
3	E70913-002	JVC Mark	1		
4	E60912-003	Speed Nut	1		
5	E70143-001	Tuning Knob	1	TUNING	
6	SBSB3008N	Tapping Screw	25		
7	E48729-009	Plastic Rivet	3		
8	E71212-001	Stopper	1		
9	E303214-001	Dial Scale	1		J,C,U,P,PG,E,A,G
10	E303214-002	Dial Scale	1		LE,LBS
11	E71142-001	Sheet	1		
12	E24630-001	Dial Back	1		
13	E66082-003	Roller Ass'y	2		
14	E24633-001	Metal Cover	1		
15	E61660-001	Special Screw	2		
16	E71133-001	Push Knob	3	Spk. MUTE OFF	
17	E69907-005	Push knob	1	LW	LE,LBS
18	E71138-001	Push Knob	5	Function	
19	E71136-001	Slide Knob	1	BALANCE	
20	E71135-001	Slide Knob	1	VOLUME	
21	VXP3108-001	Push Knob	1	POWER	
22	E71132-001	Slide Knob	2	TONE	
23	E303210-001	Knob Guide	1		
24	E71141-001	Felt Spacer	1		
25	E65119-001	Special Screw	13		
26	SPST2604N	Tapping Screw	4		
27	E70053-001	Special Screw	2		
28	E43323-002	Nut	1		
29	WAS50000Z	Washer	1		
30	E10948-001	Front Bracket	1		
31	E66082-001	Roller Ass'y	1		
32	E68113-001	Push Shaft	1	LW	LE,LBS
33	E301257-002	Tuning Shaft Ass'y	1		
34	QZD1205-003	Dial Drum	1		
35	E24631-001	Rear Panel	2		J,C
36	E24631-002	Rear Panel	3		U,P,PG
37	E24631-003	Rear Panel	4		E,A,LE,LBS
38	E24631-004	Rear Panel	1		G
39	WNS3000N	Washer	1		
40	SBSB3008N	Tapping Screw	2	LINE VOLTS	U,P,PG
41	SDSB3008N	Tapping Screw	2	AC Outlet	J,C,U,P,PG
42	QHS3876-162	Cord Stopper	1		J,C,U,P,PG,E,A,G,LE
43	QHS3876-162BS	Cord Stopper	1		LBS
44	QMG0301-003	Fuse Socket	1	Rear Panel	U,P,PG
45	E69589-002	Spacer	1	AC Outlet	J
46	E303213-001	Heat Sink	1		
47	E71236-001	Fuse Plate	1		
48	E60134-001	Special Screw	1		
49	WLS4000Z	Washer	1		
50	E303398-001	Cover	1	Power Trans	
51	E10949-001	Chassis Base Ass'y	1		
52	E303216-001	Fastener	2		
53	E301258-002	Foot	4		
54	ELP3104-B100F	Pilot Lamp	1		
55	SLB-26MW50F	L.E.D.	3		
56	SLB-26VW50F	L.E.D.	1		
57	QVZ5206-005	Volume	2	TONE	
58	QVZ5020-001	Volume	1	VOLUME	
59	QVZ5307-001	Volume	1	BALANCE	
60	QSP2206-001	Push Switch	1	POWER	
61	QMS6302-128	Head Phone Jack	1		
62	QST4651-E01	Push Switch	1	Function	
63	QST8261-E02	Push Switch	1	SPEAKERS	
64	QST4101-E01	Push Switch	1	LW	LE,LBS
65	QSP0219-058	Push Switch	1	MUTE OFF	
66	ENZ1004-001	Tuning Capacitor	1		
67	E03572-016	Antenna Terminal	1		J,C,U,P,PG,E,A,G
68	EMB91YV-201A	Antenna Terminal	1		G
69	EMN00TV-402A	4P Pin Jack	2		
70	QSR0085-001	Voltage Selector	1	LINE VOLTS	U,P,PG
71	E61367-001	GND Terminal	1		
72	EQB3101-102S	Bar Antenna Coil	1		J,C,U,P,PG,E,A,G
73	EQB3204-102S	Bar Antenna Coil	1		LE,LBS
74	QMP1200-200	Power Cord	1		J
75	QMP1900-200	Power Cord	1		C
76	QMP2560-244	Power Cord	1		A
77	QMP3900-200	Power Cord	1		E,G,LE
78	QMP7600-200	Power Cord	1		U,P,PG
79	QMP9017-008BS	Power Cord	1		LBS
80	EMB90TV-801A	Speaker terminal	1		
81	QMC0437-002	AC Outlet	1		J,C,U,P,PG
82	STK4141MK2	Power I.C.	1		
83	ESK6D24-213	Relay	1		
84	QEZ0072-338	Electrostatic Capacitor	2		
85	ETP1070-10JA	Power Transformer	1		J
86	ETP1070-10CA	Power Transformer	1		C
87	ETP1070-10FA	Power Transformer	1		U,P,PG
88	ETP1070-10EA	Power Transformer	1		E,A,G,LE
89	ETP1070-10EABS	Power Transformer	1		LBS

The Marks for Designated Areas.
 J..... U.S.A
 C..... Canada
 P,PG..... U.S.Military
 E,LE..... Europe
 G..... West Germany
 A..... Australia
 LBS..... U.K.
 U..... Other Countries

Each Individual P.C.Board Location

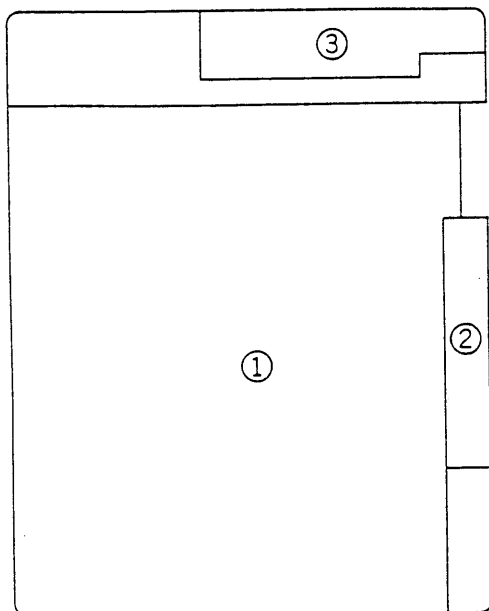

Fig. 3

- ① Tuner P.C.Board Ass'y
- ② LED P.C.Board Ass'y
- ③ Volume P.C.Board Ass'y

The Marks for Designated Areas

- A U.S.A., Canada, U.S. Military
- B Europe, Australia
- C Europe (LW), U.K.
- D West Germany

Transistors

ITEM	PART NUMBER	DESCRIPTION	
			MAKER
Q101	2SK168(E,F)	F.E.T.	HITACHI
Q102	2SC535(B,C)	SILICON	HITACHI
Q103	2SC461(C)	SILICON	HITACHI
Q104	2SC461(C)	SILICON	HITACHI
Q105	2SC535(B,C)	SILICON	HITACHI
Q351	2SC458(D)	SILICON	HITACHI

IC

ITEM	PART NUMBER	DESCRIPTION	
			MAKER
IC101	HA1137W		HITACHI
IC102	LA3400		SANYO
IC201	LA1245		SANYO
IC301	NJM4558D-D		DAINICHI

Diodes

ITEM	PART NUMBER	DESCRIPTION	
			MAKER
D131	1S2076-31	SILICON	HITACHI
D132	1S2076-31	SILICON	HITACHI
D171	1S2076-31	SILICON	HITACHI
D172	1S2076-31	SILICON	HITACHI
D173	1S2076-31	SILICON	HITACHI
D351	1S2076-31	SILICON	HITACHI
D361	SLB-26MW50F	L.E.D.	
D362	SLB-26MW50F	L.E.D.	
D363	SLB-26MW50F	L.E.D.	
D364	SLB-26VW50F	L.E.D.	

Coil

ITEM	PART NUMBER	DESCRIPTION	
L101	EQR2306-015	RF COIL	A B C D
L101	EQR2306-015	RF COIL	
L101	EQR2306-015	RF COIL	
L101	EQR2306-017	RF COIL	
L102	EQR2306-003	RF COIL	
L103	EQR2406-001	RF COIL	C C C
L104	EQL3001-1R5K	INDUCTOR	
L105	EQF0102-001	FILTER	
L201	EQL3001-102K	INDUCTOR	
L202	EQL3001-2R2K	INDUCTOR	
L251	EQR1210-006	RF COIL	
L252	EQR1310-004	RF COIL	
L253	EQL3001-2R2K	INDUCTOR	
T131	EQT2140-008	I.F. TRANSFORMER	
T132	EQT2140-009	I.F. TRANSFORMER	
T201	EQT1021-004	I.F. TRANSFORMER	

Capacitors

ITEM	PART NUMBER	DESCRIPTION			
C101	QCS21HJ-100H	10PF	50V	CERAMIC	A B C D
C102	QCF21HP-103H	0.01MF	50V	CERAMIC	
C103	QCS21HJ-150H	15PF	50V	CERAMIC	
C104	QCS21HJ-3R0H	3PF	50V	CERAMIC	
C104	QCS21HJ-4R0H	4PF	50V	CERAMIC	D
C104	QCS21HJ-4R0H	4PF	50V	CERAMIC	
C104	QCS21HJ-4R0H	4PF	50V	CERAMIC	
C105	QCS21HJ-2R0H	2PF	50V	CERAMIC	
C106	QCS21HJ-5R0H	5PF	50V	CERAMIC	
C107	QCF21HP-103H	0.01MF	50V	CERAMIC	
C108	QCF21HP-103H	0.01MF	50V	CERAMIC	
C109	QCS21HJ-151H	150PF	50V	CERAMIC	
C110	QCT26CH-100H	10PF	50V	CERAMIC	
C111	QCT26CH-220H	22PF	50V	CERAMIC	
C112	QCT26CH-7R0H	7PF	50V	CERAMIC	

Capacitors

ITEM	PART NUMBER	DESCRIPTION		
C113	QCT26RH-180H	18PF	50V	CERAMIC
C115	ENZ1003-004			TRIMMER
C116	QCF21HP-103H	0.01MF	50V	CERAMIC
C117	QCF21HP-103H	0.01MF	50V	CERAMIC
C118	QCF21HP-223H	0.022MF	50V	CERAMIC
C131	QCF21HP-223H	0.022MF	50V	CERAMIC
C132	QCF21HP-223H	0.022MF	50V	CERAMIC
C133	QCS21HJ-151H	150PF	50V	CERAMIC
C133	QCS21HJ-151H	150PF	50V	CERAMIC
C133	QCS21HJ-151H	150PF	50V	CERAMIC
C133	QCS21HJ-151H	150PF	50V	CERAMIC
C133	QCS21HJ-331H	330PF	50V	CERAMIC
C134	QCF21HP-223H	0.022MF	50V	CERAMIC
C135	QCF21HP-223H	0.022MF	50V	CERAMIC
C136	QCC21EM-473H	0.047MF	25V	CERAMIC
C137	QCF21HP-223H	0.022MF	50V	CERAMIC
C138	QCF21HP-223H	0.022MF	50V	CERAMIC
C141	QET51EM-106	10MF	25V	ELECTORO
C142	QET51HM-105	1MF	50V	ELECTORO
C143	QET51HM-475	4.7MF	50V	ELECTORO
C144	QET51HM-475	4.7MF	50V	ELECTORO
C145	QET51CM-107	100MF	16V	ELECTORO
C171	QET51EM-106	10MF	25V	ELECTORO
C173	QET51HM-105	1MF	50V	ELECTORO
C174	QET51HM-105	1MF	50V	ELECTORO
C175	QEB51HM-105	1MF	50V	L.L.C.E.
C176	QED51HM-474	0.47MF	50V	ELECTORO
C177	QET51CM-107	100MF	16V	ELECTORO
C178	QFM31HK-473	0.047MF	50V	MYLAR
C180	QCC21EM-223H	0.022MF	25V	CERAMIC
C191	QCS21HJ-331H	330PF	50V	CERAMIC
C191	QCS21HJ-331H	330PF	50V	CERAMIC
C191	QCS21HJ-331H	330PF	50V	CERAMIC
C191	QCS21HJ-471H	470PF	50V	CERAMIC
C192	QCS21HJ-331H	330PF	50V	CERAMIC
C192	QCS21HJ-331H	330PF	50V	CERAMIC
C192	QCS21HJ-331H	330PF	50V	CERAMIC
C192	QCS21HJ-471H	470PF	50V	CERAMIC
C193	QET51HM-105	1MF	50V	ELECTORO
C194	QET51HM-105	1MF	50V	ELECTORO
C195	QCY21HK-472H	4700PF	50V	CERAMIC
C196	QCY21HK-472H	4700PF	50V	CERAMIC
C201	QCY21HK-102H	1000PF	50V	CERAMIC
C202	QCF21HP-223H	0.022MF	50V	CERAMIC
C203	QCF21HP-223H	0.022MF	50V	CERAMIC
C204	QCF21HP-223H	0.022MF	50V	CERAMIC
C205	QCS21HJ-121H	120PF	50V	CERAMIC
C206	QCY21HK-102H	1000PF	50V	CERAMIC
C207	QCF21HP-223H	0.022MF	50V	CERAMIC
C208	QET51CM-226	22MF	16V	ELECTORO
C209	QCF21HP-223H	0.022MF	50V	CERAMIC
C210	QFM31HK-223	0.022MF	50V	MYLAR
C211	QCF21HP-223H	0.022MF	50V	CERAMIC
C212	QET51HM-105	1MF	50V	ELECTORO
C213	QET51HM-475	4.7MF	50V	ELECTORO
C214	QET51HM-225	2.2MF	50V	ELECTORO
C215	QCF21HP-223H	0.022MF	50V	CERAMIC
C216	QCF21HP-223H	0.022MF	50V	CERAMIC
C217	QET51CM-226	22MF	16V	ELECTORO
C221	QFM31HK-822	0.082MF	50V	MYLAR
C222	QFM31HK-473	0.047MF	50V	MYLAR
C223	QFM31HK-473	0.047MF	50V	MYLAR
C224	QAT2001-005	15PF	50V	TRIMMER
C225	QCS21HJ-150H	15PF	50V	CERAMIC
C251	QCT26CH-181H	180PF	50V	CERAMIC
C252	QCT26CH-181H	180PF	50V	CERAMIC
C253	QCT26UJ-220H	22PF	50V	CERAMIC
C254	QCT26CH-101H	100PF	50V	CERAMIC
C255	QCT26CH-470H	47PF	50V	CERAMIC
C256	QCT26RH-270H	27PF	50V	CERAMIC
C257	QCT26CH-330H	33PF	50V	CERAMIC
C258	QAT2001-005	15PF	50V	TRIMMER
C301	QET51HM-475	4.7MF	50V	ELECTORO
C302	QET51HM-475	4.7MF	50V	ELECTORO
C303	QCS21HJ-331H	330PF	50V	CERAMIC
C304	QCS21HJ-331H	330PF	50V	CERAMIC
C305	QET51HM-225	2.2MF	50V	ELECTORO
C306	QET51HM-225	2.2MF	50V	ELECTORO
C307	QCY21HK-182H	1800PF	50V	CERAMIC

Capacitors

ITEM	PART NUMBER	DESCRIPTION		
C308	QCY21HK-182H	1800PF	50V	CERAMIC
C309	QCY21HK-682H	6800PF	50V	CERAMIC
C310	QCY21HK-682H	6800PF	50V	CERAMIC
C311	QCS21HJ-331H	330PF	50V	CERAMIC
C311	QCS21HJ-560H	56PF	50V	CERAMIC
C311	QCS21HJ-560H	56PF	50V	CERAMIC
C311	QCS21HJ-560H	56PF	50V	CERAMIC
C312	QCS21HJ-331H	330PF	50V	CERAMIC
C312	QCS21HJ-560H	56PF	50V	CERAMIC
C312	QCS21HJ-560H	56PF	50V	CERAMIC
C312	QCS21HJ-560H	56PF	50V	CERAMIC
C313	QET51EM-106	10MF	25V	ELECTORO
C314	QET51EM-106	10MF	25V	ELECTORO
C351	QET51HM-475	4.7MF	50V	ELECTORO
C401	QCF21HP-223H	0.022MF	50V	CERAMIC
C402	QCF21HP-223H	0.022MF	50V	CERAMIC
C411	QCS21HJ-181H	180PF	50V	CERAMIC
C412	QCS21HJ-181H	180PF	50V	CERAMIC
C413	QFM31HK-183	0.018MF	50V	MYLAR
C414	QFM31HK-183	0.018MF	50V	MYLAR

Resistors

ITEM	PART NUMBER	DESCRIPTION		
R101	QRD148J-330SN	33	1/4W	CARBON
R102	QRD148J-221SN	220	1/4W	CARBON
R103	QRD148J-102SN	1K	1/4W	CARBON
R104	QRD148J-302SN	3K	1/4W	CARBON
R104	QRD148J-472SN	4.7K	1/4W	CARBON
R104	QRD148J-472SN	4.7K	1/4W	CARBON
R104	QRD148J-472SN	4.7K	1/4W	CARBON
R105	QRD148J-223SN	22K	1/4W	CARBON
R105	QRD148J-223SN	22K	1/4W	CARBON
R105	QRD148J-223SN	22K	1/4W	CARBON
R105	QRD148J-223SN	22K	1/4W	CARBON
R106	QRD148J-272SN	2.2K	1/4W	CARBON
R107	QRD148J-103SN	10K	1/4W	CARBON
R108	QRD148J-682SN	6.8K	1/4W	CARBON
R109	QRD148J-222SN	2.2K	1/4W	CARBON
R110	QRD148J-102SN	1K	1/4W	CARBON
R111	QRD148J-392SN	3.9K	1/4W	CARBON
R112	QRD148J-221SN	220	1/4W	CARBON
R113	QRD148J-102SN	1K	1/4W	CARBON
R115	QRD148J-222SN	2.2K	1/4W	CARBON
R116	QRD148J-102SN	1K	1/4W	CARBON
R117	QRD148J-391SN	390	1/4W	CARBON
R118	QRD148J-101SN	100	1/4W	CARBON
R119	QRZ0062-330	33	1/4W	FUSIBLE
R119	QRZ0062-330	33	1/4W	FUSIBLE
R119	QRZ0062-330	33	1/4W	FUSIBLE
R120	QRD148J-472SN	4.7K	1/4W	CARBON
R131	QRD148J-331SN	330	1/4W	CARBON
R132	QRD148J-103SN	10K	1/4W	CARBON
R133	QRD148J-562SN	5.6K	1/4W	CARBON
R133	QRD148J-330S	33	1/4W	CARBON
R134	QRZ0062-330	33	1/4W	FUSIBLE
R134	QRZ0062-330	33	1/4W	FUSIBLE
R134	QRZ0062-330	33	1/4W	FUSIBLE
R135	QRD148J-472SN	4.7K	1/4W	CARBON
R141	QRD148J-222SN	2.2K	1/4W	CARBON
R141	QRD148J-202SN	2K	1/4W	CARBON
R141	QRD148J-222SN	2.2K	1/4W	CARBON
R142	QRD148J-113SN	11K	1/4W	CARBON
R142	QRD148J-123SN	12K	1/4W	CARBON
R142	QRD148J-123SN	12K	1/4W	CARBON
R143	QRD148J-561SN	560	1/4W	CARBON
R145	QRD148J-102SN	1K	1/4W	CARBON
R171	EVP314-7-315			VARIABLE
R171	EVP314-7-315			VARIABLE
R171	EVP314-7-315			VARIABLE
R171	QRD148J-223SN	22K	1/4W	CARBON
R172	QRD148J-103SN	10K	1/4W	CARBON
R173	QRD148J-472SN	4.7K	1/4W	CARBON

△ Safety Parts

Resistors

ITEM	PART NUMBER	DESCRIPTION	
R174	QRD148J-103SN	10K	1/4W CARBON
R176	QRD148J-222SN	2.2K	1/4W CARBON
R177	QRD148J-332SN	3.3K	1/4W CARBON
R178	QRD145J-330S	33	1/4W CARBON
R178	QRZ0062-330	33	1/4W FUSIBLE Δ
R178	QRZ0062-330	33	1/4W FUSIBLE Δ
R178	QRZ0062-330	33	1/4W FUSIBLE Δ
R181	QRD148J-184SN	180K	1/4W CARBON
R182	QRD148J-184SN	180K	1/4W CARBON
R191	QRD148J-134SN	130K	1/4W CARBON
R192	QRD148J-134SN	130K	1/4W CARBON
R193	QRD148J-332SN	3.3K	1/4W CARBON
R194	QRD148J-332SN	3.3K	1/4W CARBON
R195	QRD148J-562SN	5.6K	1/4W CARBON
R196	QRD148J-562SN	5.6K	1/4W CARBON
R201	QRD148J-152SN	1.5K	1/4W CARBON
R202	QRD148J-271SN	270	1/4W CARBON
R203	QRD148J-471SN	470	1/4W CARBON
R204	QRD148J-221SN	220	1/4W CARBON
R205	QRD148J-103SN	10K	1/4W CARBON
R206	QRD148J-103SN	10K	1/4W CARBON
R207	QRD148J-103SN	10K	1/4W CARBON
R208	QRD148J-822SN	8.2K	1/4W CARBON
R209	QRZ0062-680	68	1/4W FUSIBLE Δ
R209	QRZ0062-680	68	1/4W FUSIBLE Δ
R209	QRZ0062-680	68	1/4W FUSIBLE Δ
R301	QRD148J-222SN	2.2K	1/4W CARBON
R302	QRD148J-222SN	2.2K	1/4W CARBON
R303	QRD148J-563SN	56K	1/4W CARBON
R304	QRD148J-563SN	56K	1/4W CARBON
R305	QRD148J-104SN	100K	1/4W CARBON
R306	QRD148J-104SN	100K	1/4W CARBON
R307	QRD148J-821SN	820	1/4W CARBON
R308	QRD148J-821SN	820	1/4W CARBON
R311	QRD148J-393SN	39K	1/4W CARBON
R312	QRD148J-393SN	39K	1/4W CARBON
R313	QRD148J-474SN	470K	1/4W CARBON
R314	QRD148J-474SN	470K	1/4W CARBON
R315	QRD148J-181SN	180	1/4W CARBON
R316	QRD148J-181SN	180	1/4W CARBON
R351	QRD148J-183SN	18K	1/4W CARBON
R352	QRD148J-472SN	4.7K	1/4W CARBON
R353	QRD148J-333SN	33K	1/4W CARBON
R354	QRD148J-101SN	100	1/4W CARBON
R355	QRD148J-151SN	150	1/4W CARBON
R356	QRD148J-681SN	680	1/4W CARBON
R361	QRD148J-331SN	330	1/4W CARBON
R362	QRD148J-181SN	180	1/4W CARBON
R363	QRD148J-222SN	2.2K	1/4W CARBON
R401	QRD148J-332SN	3.3K	1/4W CARBON
R402	QRD148J-332SN	3.3K	1/4W CARBON
R411	QRD148J-683SN	68K	1/4W CARBON
R412	QRD148J-683SN	68K	1/4W CARBON
R413	QRD148J-223SN	22K	1/4W CARBON
R414	QRD148J-223SN	22K	1/4W CARBON
R451	QRZ0062-220	22	1/4W FUSIBLE Δ
R451	QRD125J-330	33	1/2W CARBON Δ
R451	QRZ0062-220	22	1/4W FUSIBLE Δ
R451	QRZ0062-220	22	1/4W FUSIBLE Δ
VR401	QVZ5307-001		VARIABLE
VR402	QVZ5020-001		VARIABLE

 Δ Safety Parts

Others

ITEM	PART NUMBER	DESCRIPTION
	EMN00TV-402A	PIN JACK ASS'Y
	EMBIYV-201A	TERMINAL BOARD
	E03572-016	TERMINAL BOARD
	E03572-016	TERMINAL BOARD
	E03572-016	TERMINAL BOARD
	E67764-002	TERMINAL ASS'Y
	E67764-002	TERMINAL ASS'Y
	E67764-002	TERMINAL ASS'Y
	E67764-002	TERMINAL ASS'Y
	E67764-003	TERMINAL ASS'Y
	E67764-006	WRAPPING TERMINAL
	E10953-002	CIRCUIT BOARD
	QHW1052-001	WIRE CLAMP
	E65396-003	EARTH PLATE
	E70225-001	EARTH PLATE
	E71007-001	SHIELD CASE
	E71008-001	SHIELD CASE
P401	E04365-003	3P SOCKET
S401	QST4651-E01	PUSH SWITCH
S406	QST4101-E10	PUSH SWITCH
S407	QSP0219-058	PUSH SWITCH
CF101	ECB2118-001	CERAMIC FILTER
CF101	ECB2118-001	CERAMIC FILTER
CF101	ECB2118-001	CERAMIC FILTER
CF101	ECB2118-001	CERAMIC FILTER
CF101	ECB2123-001	CERAMIC FILTER
CF102	ECB2118-001	CERAMIC FILTER
CF102	ECB2118-001	CERAMIC FILTER
CF102	ECB2118-001	CERAMIC FILTER
CF102	ECB2123-001	CERAMIC FILTER
CF171	ECX0000-456KS	RESONATOR
CF201	ECB1510-001	CERAMIC FILTER
LF101	EQF0101-005	FILTER
	ENZ1004-001	VARICAP

3-(2) ENH-026 Amplifier P.C. Board Ass'y

Note: ENH-026 varies according to the areas employed. See note (1) when placing an order.

Note (1)

Designated Areas	P.C. Board Ass'y
U.S.A.	ENH-026 A
Canada	ENH-026 B
Europe	ENH-026 D
Australia	ENH-026 G
West Germany	ENH-026 F
U.K.	ENH-026 EBS
U.S. Military Market and Other Countries	ENH-026 C

Note (2)

The symbols (赤、黒、白 ... etc.) on P.C. Board surface are factory process only.

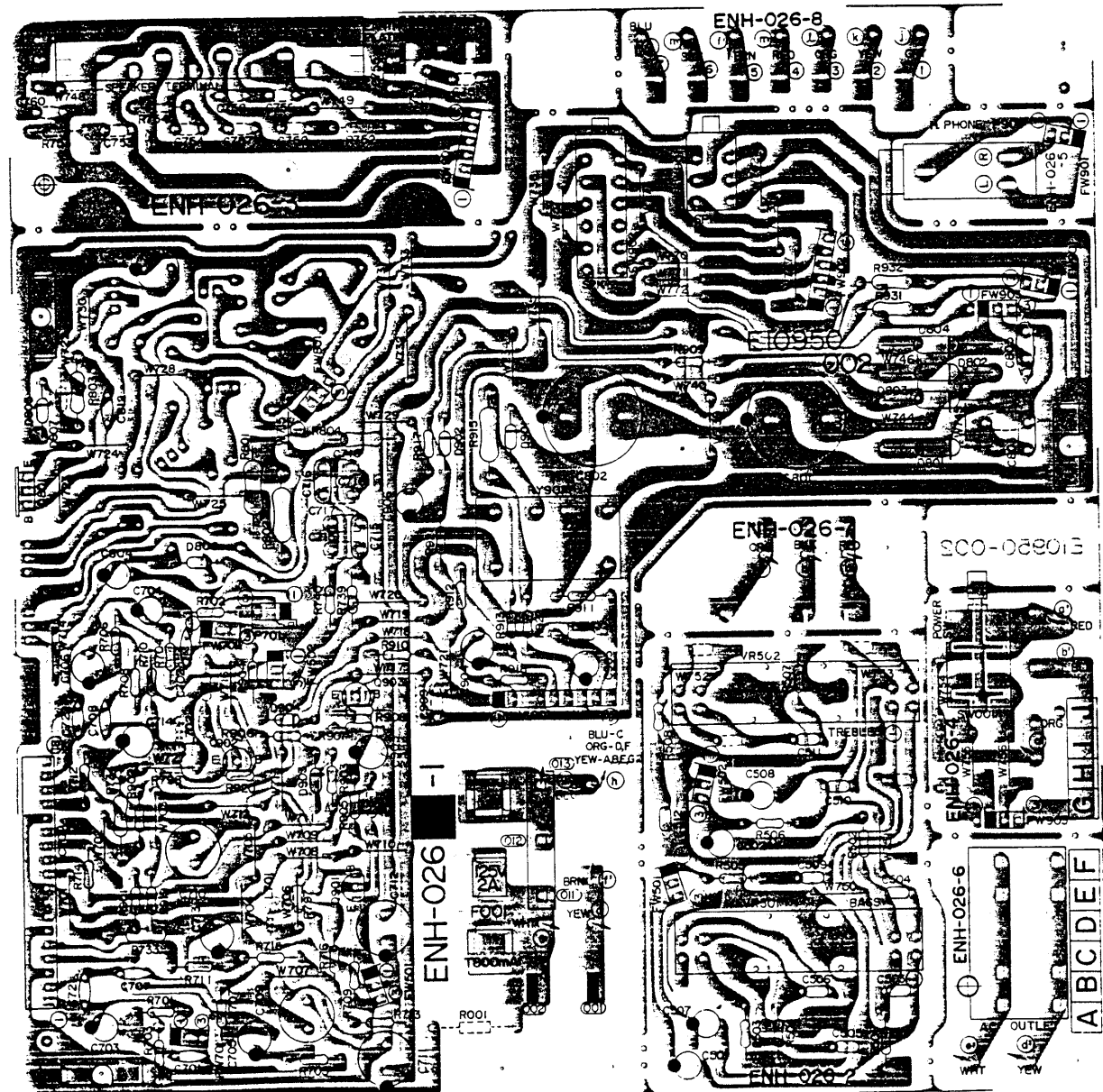

Fig. 4

Each Individual P.C.Board Location

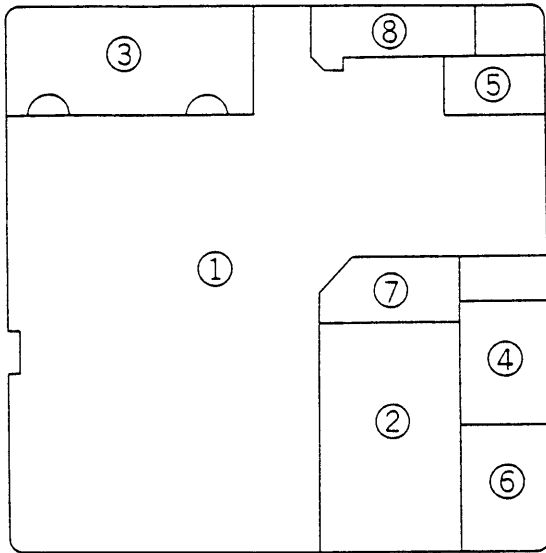

Fig. 5

- ① Main Anp. P.C.Board Ass'y
- ② Tone Control P.C.Board Ass'y
- ③ Speaker Terminal P.C.Board Ass'y
- ④ Power Switch P.C.Board Ass'y
- ⑤ Headphone P.C.Board Ass'y
- ⑥ AC Outlet P.C.Board Ass'y
- ⑦ Secondary P.C.Board Ass'y
- ⑧ Primary P.C.Board Ass'y

The Marks for Designated Areas

- A U.S.A.
- B Canada
- D Europe
- G Australia
- F West Germany
- EBS . . . U.K.
- C U.S'.Militaly, Other Countries

Transistors

ITEM	PART NUMBER	DESCRIPTION	
		M A K E R	
Q801	2SD1265A(O,P)	SILICON	MATSUSHITA
Q901	2SC1775(E,F)	SILICON	NEC
Q902	2SC1775(E,F)	SILICON	NEC
Q903	2SA733A(P,Q)	SILICON	NEC

Diodes

ITEM	PART NUMBER	DESCRIPTION	
D901	1S2076-31	SILICON	HITACHI
D902	1S2076-31	SILICON	HITACHI
D903	1S2076-31	SILICON	HITACHI
D904	1S2076-31	SILICON	HITACHI

IC

ITEM	PART NUMBER	DESCRIPTION	
		M A K E R	
IC701	STK4141MK2	SANYO	
IC901	TA7317P	TOSHIBA	

Coil

ITEM	PART NUMBER	DESCRIPTION
L701	EQL0001-R45	INDUCTOR
L702	EQL0001-R45	INDUCTOR

Capacitors

ITEM	PART NUMBER	DESCRIPTION		
C501	QET51EM-106	10MF	25V	ELECTORO
C502	QET51EM-106	10MF	25V	ELECTORO
C503	QFM31HK-153	0.015MF	50V	MYLER
C504	QFM31HK-153	0.015MF	50V	MYLER
C505	QFM31HK-823	0.082MF	50V	MYLAR
C506	QFM31HK-823	0.082MF	50V	MYLAR
C507	QET51EM-106	10MF	25V	ELECTORO
C508	QET51EM-106	10MF	25V	ELECTORO
C509	QFM31HK-332	3300PF	50V	MYLAR
C510	QFM31HK-332	3300PF	50V	MYLAR
C511	QFM31HK-183	0.018MF	50V	MYLAR
C512	QFM31HK-183	0.018MF	50V	MYLAR
C701	QCS21HJ-680H	68PF	50V	CERAMIC
C702	QCS21HJ-680H	68PF	50V	CERAMIC
C703	QET51HM-225	2.2MF	50V	ELECTORO
C704	QET51HM-225	2.2MF	50V	ELECTORO
C705	QET51AM-476	47MF	10V	ELECTORO
C706	QET51AM-476	47MF	10V	ELECTORO
C707	QCS21HJ-100H	10PF	50V	CERAMIC
C708	QCS21HJ-100H	10PF	50V	CERAMIC

Diodes

ITEM	PART NUMBER	DESCRIPTION	
		M A K E R	
D801	S3V20F	SILICON	SHINDENGEN Δ
D802	S3V20F	SILICON	SHINDENGEN Δ
D803	S3V20F	SILICON	SHINDENGEN Δ
D804	S3V20F	SILICON	SHINDENGEN Δ
D805	RD15EB3	SILICON	NEC
D806	RD15EB3	SILICON	NEC
D807	1S2076-31	SILICON	HITACHI
D807	1S2076-31	SILICON	HITACHI
D807	1S2076-31	SILICON	HITACHI
D807	1S2076-31	SILICON	HITACHI

D
EBS
F
G

Δ Safety Parts

Δ Safety Parts

Capacitors

ITEM	PART NUMBER	DESCRIPTION		
C709	QEN51HM-107	100MF	50V	ELECTORO
C710	QEN51HM-107	100MF	50V	ELECTORO
C711	QET51HM-107	100MF	50V	ELECTORO
C712	QET51HM-107	100MF	50V	ELECTORO
C713	QET51EM-476	47MF	25V	ELECTORO
C714	QET51EM-476	47MF	25V	ELECTORO
C715	QFM31HK-473	0.047MF	50V	MYLAR
C716	QFM31HK-473	0.047MF	50V	MYLAR
C717	QFM31HK-473	0.047MF	50V	MYLAR
C717	QFM31HK-473	0.047MF	50V	MYLAR
C717	QFM31HK-473	0.047MF	50V	MYLAR
C717	QFM31HK-473	0.047MF	50V	MYLAR
C717	QFM31HK-473	0.047MF	50V	MYLAR
C717	QFM31HK-473	0.047MF	50V	MYLAR
C717	QFM31HK-473	0.047MF	50V	MYLAR
C717	QFM31HK-473	0.047MF	50V	MYLAR
C717	QFM31HK-473	0.047MF	50V	MYLAR
C718	QFM31HK-473	0.047MF	50V	MYLAR
C718	QFM31HK-473	0.047MF	50V	MYLAR
C718	QFM31HK-473	0.047MF	50V	MYLAR
C721	QCS21HJ-221H	220PF	50V	CERAMIC
C722	QCS21HJ-221H	220PF	50V	CERAMIC
C751	QFM31HK-473	0.047MF	50V	MYLAR
C752	QFM31HK-473	0.047MF	50V	MYLAR
C753	QFM31HK-473	0.047MF	50V	MYLAR
C754	QFM31HK-473	0.047MF	50V	MYLAR
C755	QCS21HJ-271H	270PF	50V	CERAMIC
C756	QCS21HJ-271H	270PF	50V	CERAMIC
C759	QCS21HJ-331H	330PF	50V	CERAMIC
C760	QCS21HJ-331H	330PF	50V	CERAMIC
C801	QE20072-338	3300MF	50V	ELECTORO
C802	QE20072-338	3300MF	50V	ELECTORO
C803	QFM82AK-473	0.047MF	100V	MYLAR
C804	QET51EM-106	10MF	25V	ELECTORO
C805	QFM82AK-473	0.047MF	100V	MYLAR
C806	QET51EM-107	100MF	25V	ELECTORO
C812	QCF21HP-103H	0.01MF	50V	CERAMIC
C903	QET51HM-226	22MF	50V	ELECTORO
C904	QET51AM-107	100MF	10V	ELECTORO
C905	QET51CM-226	22MF	16V	ELECTORO
C906	QET51HM-105	1MF	50V	ELECTORO

△ Safety Parts

Resistors

ITEM	PART NUMBER	DESCRIPTION		
R001	QRC128K-275EM	2.7M	1/2W	COMPOSI
R001	QRC128K-275EM	2.7M	1/2W	COMPOSI
R503	QRD148J-362SN	3.6K	1/4W	CARBON
R504	QRD148J-362SN	3.6K	1/4W	CARBON
R505	QRD148J-472SN	4.7K	1/4W	CARBON
R506	QRD148J-472SN	4.7K	1/4W	CARBON
R507	QRD148J-821SN	820	1/4W	CARBON
R508	QRD148J-821SN	820	1/4W	CARBON
R701	QRD148J-102SN	1K	1/4W	CARBON
R702	QRD148J-102SN	1K	1/4W	CARBON
R703	QRD148J-104SN	100K	1/4W	CARBON
R704	QRD148J-104SN	100K	1/4W	CARBON
R705	QRD148J-681SN	680	1/4W	CARBON
R706	QRD148J-681SN	680	1/4W	CARBON
R707	QRD148J-133SN	13K	1/4W	CARBON
R708	QRD148J-133SN	13K	1/4W	CARBON
R709	QRD148J-823SN	8.2K	1/4W	CARBON
R710	QRD148J-823SN	8.2K	1/4W	CARBON
R711	QRD148J-222SN	2.2K	1/4W	CARBON
R712	QRD148J-222SN	2.2K	1/4W	CARBON
R713	QRD145J-221S	220	1/4W	CARBON
R713	QRD145J-221S	220	1/4W	CARBON
R713	QRD145J-221S	220	1/4W	CARBON
R713	QRZ0062-221	220	1/4W	FUSIBLE
R713	QRZ0062-221	220	1/4W	FUSIBLE

△ Safety Parts

Resistors

ITEM	PART NUMBER	DESCRIPTION		
R713	QRZ0062-221	220	1/4W	FUSIBLE
R713	QRZ0062-221	220	1/4W	FUSIBLE
R714	QRD145J-101S	100	1/4W	CARBON
R714	QRD145J-101S	100	1/4W	CARBON
R714	QRD145J-101S	100	1/4W	CARBON
R714	QRZ0062-101	100	1/4W	FUSIBLE
R714	QRZ0062-101	100	1/4W	FUSIBLE
R714	QRZ0062-101	100	1/4W	FUSIBLE
R714	QRZ0062-101	100	1/4W	FUSIBLE
R715	QRD148J-222SN	2.2K	1/4W	CARBON
R716	QRD148J-222SN	2.2K	1/4W	CARBON
R733	QRX022J-R22AM	0.22	2W	UNF. CARBON
R734	QRX022J-R22AM	0.22	2W	UNF. CARBON
R739	QRD145J-100S	10	1/4W	CARBON
R740	QRD145J-100S	10	1/4W	CARBON
R751	QRZ0062-100	10	1/4W	FUSIBLE
R752	QRZ0062-100	10	1/4W	FUSIBLE
R753	QRZ0062-100	10	1/4W	FUSIBLE
R754	QRZ0062-100	10	1/4W	FUSIBLE
R797	QRD145J-470S	47	1/4W	CARBON
R798	QRD145J-470S	47	1/4W	CARBON
R801	QRG026J-680A	680	2W	O.M. FILM
R802	QRG026J-680A	680	2W	O.M. FILM
R803	QRD125J-182	1.5K	1/2W	CARBON
R804	QRD125J-152	1.5K	1/2W	CARBON
R901	QRD148J-152SN	1.5K	1/4W	CARBON
R902	QRD148J-152SN	1.5K	1/4W	CARBON
R903	QRD148J-562SN	5.6K	1/4W	CARBON
R904	QRD148J-562SN	5.6K	1/4W	CARBON
R905	QRD148J-123SN	12K	1/4W	CARBON
R906	QRD148J-123SN	12K	1/4W	CARBON
R907	QRD148J-103SN	10K	1/4W	CARBON
R908	QRD148J-332SN	3.3K	1/4W	CARBON
R909	QRD148J-472SN	4.7K	1/4W	CARBON
R910	QRD148J-563SN	5.6K	1/4W	CARBON
R911	QRD148J-183SN	18K	1/4W	CARBON
R912	QRD148J-683SN	68K	1/4W	CARBON
R913	QRD148J-153SN	15K	1/4W	CARBON
R914	QRD148J-224SN	220K	1/4W	CARBON
R915	QRG022J-391AM	390	2W	O.M. FI
R917	QRD148J-223SN	22K	1/4W	CARBON
R918	QRD148J-104SN	100K	1/4W	CARBON
R919	QRD148J-104SN	100K	1/4W	CARBON
R920	QRD148J-104SN	100K	1/4W	CARBON
R921	QRD148J-563SN	5.6K	1/4W	CARBON
R922	QRD148J-820SN	82	1/4W	CARBON
R931	QRD125J-221	220	1/2W	CARBON
R932	QRD125J-221	220	1/2W	CARBON
R998	QRD148J-472SN	4.7K	1/4W	CARBON
VR501	QVZ5206-005			VALIABLE
VR502	QVZ5206-005			VALIABLE

△ Safety Parts

Others

ITEM	PART NUMBER	DESCRIPTION	
	E04365-003	3P SOCKET	
	QMC0437-002	AC OUTLET	△
	QMC0437-002	AC OUTLET	△
	QMC0437-002	AC OUTLET	△
	E45524-002	FUSE CLIP	△
	E45524-002	FUSE CLIP	△
	E67764-203	TERMINAL ASS'Y	
	E65508-002	TAB	
	EMB90TV-801A	SPEAKER TERMINAL	
	EMG7331-001	FUSE CLIP	△
	EMG7331-001	FUSE CLIP	△
	EMG7331-001	FUSE CLIP	△
	EMG7331-001	FUSE CLIP	△
	EMG7331-001	FUSE CLIP	△
	E10950-003	CIRCUIT BOARD	
	E10950-003	CIRCUIT BOARD	
	E10950-003	CIRCUIT BOARD	
	E10950-003	CIRCUIT BOARD	
	E10950-003	CIRCUIT BOARD	
	E10950-003	CIRCUIT BOARD	
	E10950-003BS	CIRCUIT BOARD	
	E71140-001	SPRING	
	S8SE3008Z	SCREW	
	E303213-001	HEAT SINK	
	E70225-001	EARTH PLATE	
P901	QMS6302-128	HEAD HONE JACK	
RY901	ESK6024-213	RELAY	
SW001	QSP2206-001	PUSH SWITCH	△
SW901	QST8261-E02	PUSH SWITCH	

A
B
C
A
B
C

C
D
EBS
F
G
A
B
C
D
EBS
F
G

F

△ Safety Parts

4. Packing Materials and Part Numbers

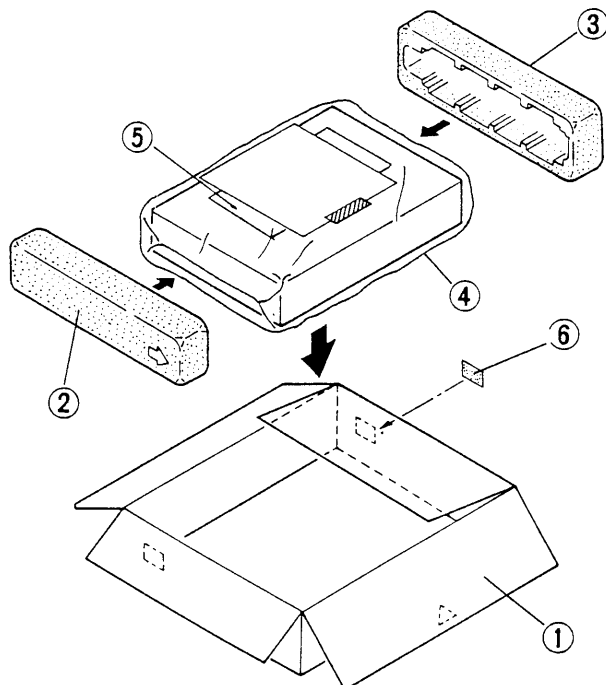

The Marks for Designated Areas.	
J U.S.A.	G West Germany
C Canada	A Australia
P.PG . . . U.S. Military	LBS U.K.
E,LE . . . Europe	U Other Countries

No.	Part Name	Part Number	Description
1	Packing Case	PK-RK100E	P. PG. E. G. A. U (E300382-361)
2		PK-RK100LE	J. C. (E300382-366) LE. LBS (E300382-368)
3	Fillers (L. R)	NZ-RK100/L E24634-002	
4	Protect Seet	E68142-005 E68142-005B	J.C.P.PG.E.G.A.LE.U LBS
5	Caution Sheet	E35497-005	P.
6	Serial Label	E35497-005 E35246-001 E35246-004 E35246-006	U. PG J.C.P.PG.A.LBS.U E. LE G

3. Dial Stringing Procedure

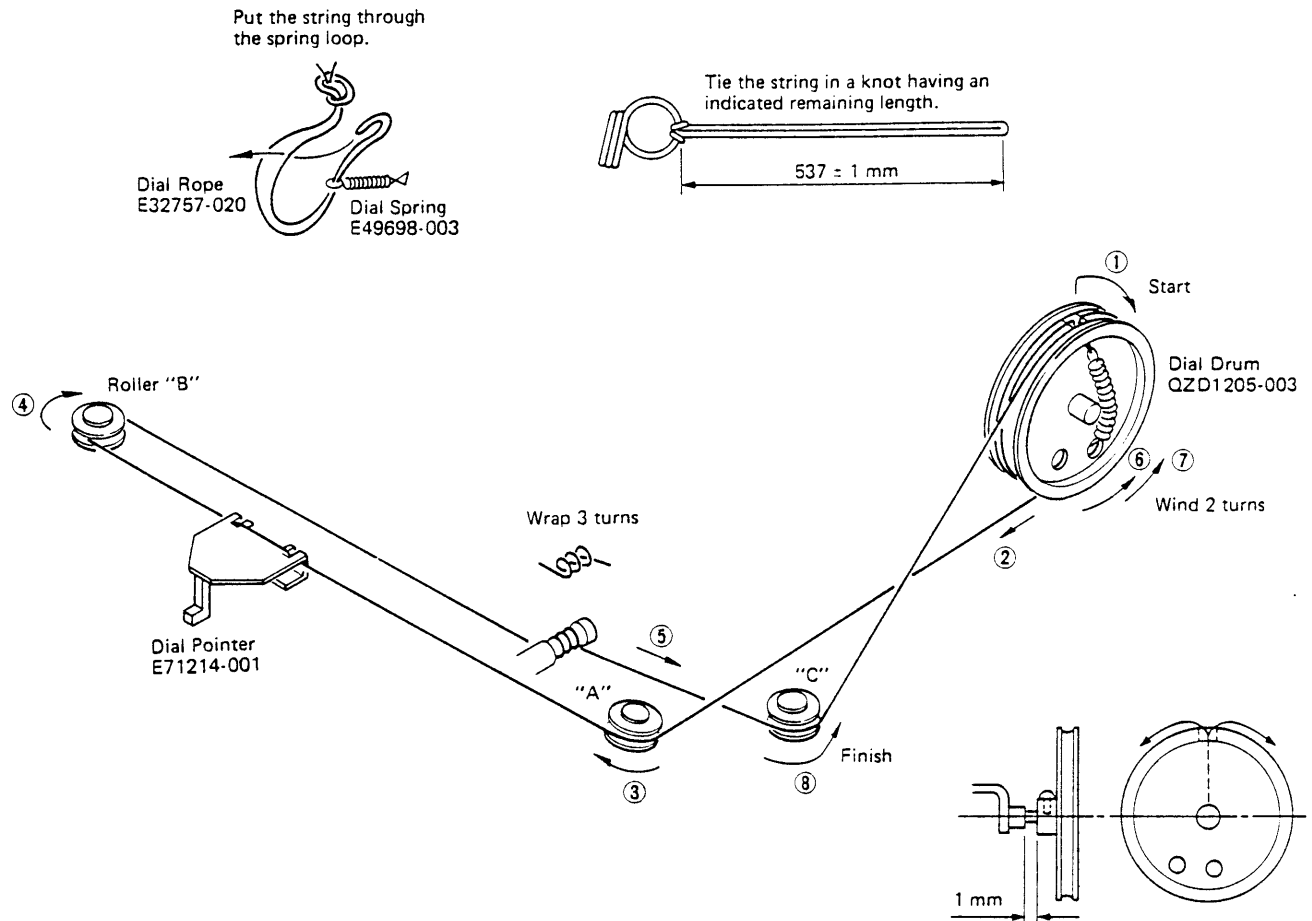

Fig. 3

- (1) Remove dial pointer and old cord.
- (2) Tie end of new dial cord to one end of dial spring, connect the other end of dial spring of bottom right eye inside dial drum.
- (3) Rotate the tuning capacitor dial drum to its maximum counterclockwise.
- (4) Run the dial cord through the slot in the rim of the dial drum. See step ①.
- (5) Guide the dial cord around, over and under rollers "A" and "B". Keep the dial cord taut during this procedure. See step ② to ④.
- (6) Pull the dial cord taut and wrap 3 turns counterclockwise around tuning shaft. See step ⑤.
- (7) Guide the dial cord over the dial drum and wind 2 turns counterclockwise. See step ⑥ and ⑦.
- (8) Pull the dial cord taut and set it around roller "C". See step ⑧.
- (9) Turn the tuning shaft to rotate the dial drum fully counterclockwise and fully clockwise to distribute the tensioning along the dial cord.
- (10) Place the dial cord over and under the tabs on the rear of the dial pointer and place the dial pointer on the top of the dial rail.
- (11) Turn the tuning shaft clockwise. Slide the dial pointer to zero (0) calibration marker on the logging scale while holding tuning shaft fully clockwise. Cement the dial pointer to the dial cord to prevent slippage. Allow cement to dry thoroughly.

4. FM/MW (LW) Tuner Alignment Procedures

4-(1) FM Section

Alignment Location on ENA-021 Tuner P.C. Board Ass'y.

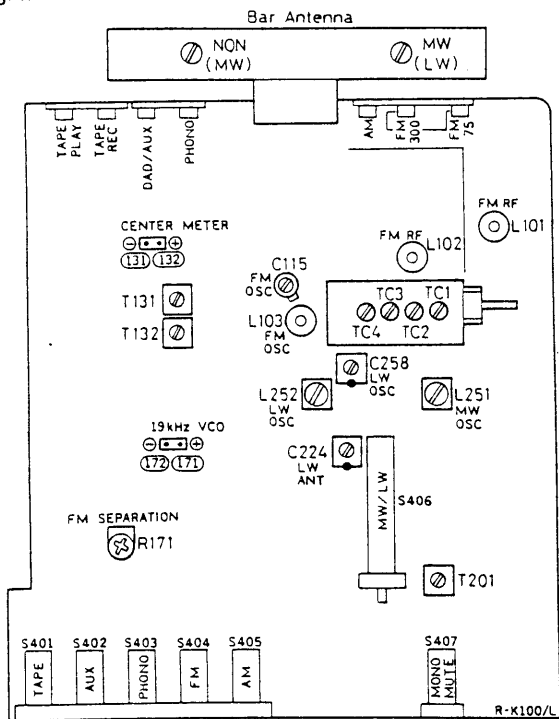

Fig. 4

Discriminator, Center Meter, Distortion and Signal Gain

1. Set to FM.
2. Connect an RF generator, 1 kHz modulation and 75 kHz deviation, to the antenna terminals on the rear panel through a dummy antenna.
3. Connect an Oscilloscope, Distortion Meter and VTVM to the Rec. Out jacks on the rear panel.
4. Tune to a frequency where there is no broadcasting.
5. Connect a DC VTVM between TP132 and 131.
6. Adjust the core of T131 for DC VTVM reading of 0 (zero) mV.
7. Set the RF generator to 98 MHz.
8. Set the dial pointer to 98 MHz.
9. Adjust the core of T132 so that the distortion is minimized at a value less than 0.4 %.

Tracking and Sensitivity

Precaution: No adjustment is necessary. The tracking and sensitivity have been adjusted properly and completely at the factory. If any special reason occasioned, take the following procedures carefully.

Low Frequency

1. Connect an RF generator to the antenna terminals on the rear panel through a dummy antenna.
2. Set the RF generator to 88 MHz, a modulation of 1 kHz and a deviation of 75 kHz to provide an input of $2 \mu\text{V}$.
3. Connect a VTVM and an Oscilloscope to the Rec. Out jacks on the rear panel.
4. Set the dial pointer to 88 MHz.
5. Adjust the three coils L103, L102 and L101 in the tuning gang to maximize the output.

High Frequency

6. Set the RF generator to 108 MHz, a modulation of 1 kHz and a deviation of 75 kHz, to provide an input of $2 \mu\text{V}$.
 7. Set the dial pointer to 108 MHz.
 8. Adjust the FM trimmers C115, TC3 and TC1 in the tuning gang to maximize the output.
 9. Repeat these high and low frequency adjustments alternately until maximum sensitivity is obtained.
- Note:** After adjustment, confirm that the band cover is as follows: (for West Germany only)
 FM: Lower 87.5 MHz -300 kHz, Higher 108.0 MHz -100 kHz

Separation (for Europe only)

1. Set the stereo signal generator as follows: 400 Hz modulation frequency, 7.5 kHz deviation pilot, 67.5 kHz main and sub carriers. Connect its output to an RF generator.
2. Connect the RF Generator to the antenna terminal through a dummy antenna.
3. Connect a VTVM, an Oscilloscope and a Distortion Meter to Signal Cord.
4. Set the RF Generator to the 98 MHz and an output of 1 mV.
5. Set the dial pointer to 98 MHz.
6. Switch the selector of the Stereo Modulator to Left channel modulation.
7. Adjust VR171 so that the output of the Right channel is minimized.
8. Switch the selector of the modulator to Right channel modulation.
9. Adjust VR171 so that the Left channel is minimized.
10. Set VR171 to average, if the separation of Right and Left are different.

4-(2) MW (LW) Section

Note: () shows LW Alignment Procedures

Tracking and Sensitivity

Low Frequency

1. Connect the RF generator to the antenna terminals on the rear panel, set this to 600 kHz (160 kHz) with 30 % modulation at 400 Hz.
2. Connect an AC VTVM and an oscilloscope to the Rec. out jacks on the rear panel.
3. Set the dial pointer to 600 kHz (160 kHz).
4. Adjust OSC coil L251 (L252) and the ferrite bar antenna core to maximize the output signal. Left ferrite bar is for MW (right ferrite bar is for LW).

High Frequency

5. Set the RF generator to 1400 kHz (350 kHz) with 30 % modulation at 400 Hz.
6. Set the dial pointer to 1400 kHz (350 kHz).
7. Adjust the trimmers TC2 (C224) and TC4 (C258) in the tuning gang so that the output signal is maximized.
8. Repeat these high and low frequency adjustment procedures alternately until maximum sensitivity is obtained.

5. R-K100/R-K100L Schematic Diagram

5-(1) R-K100 Tuner Section

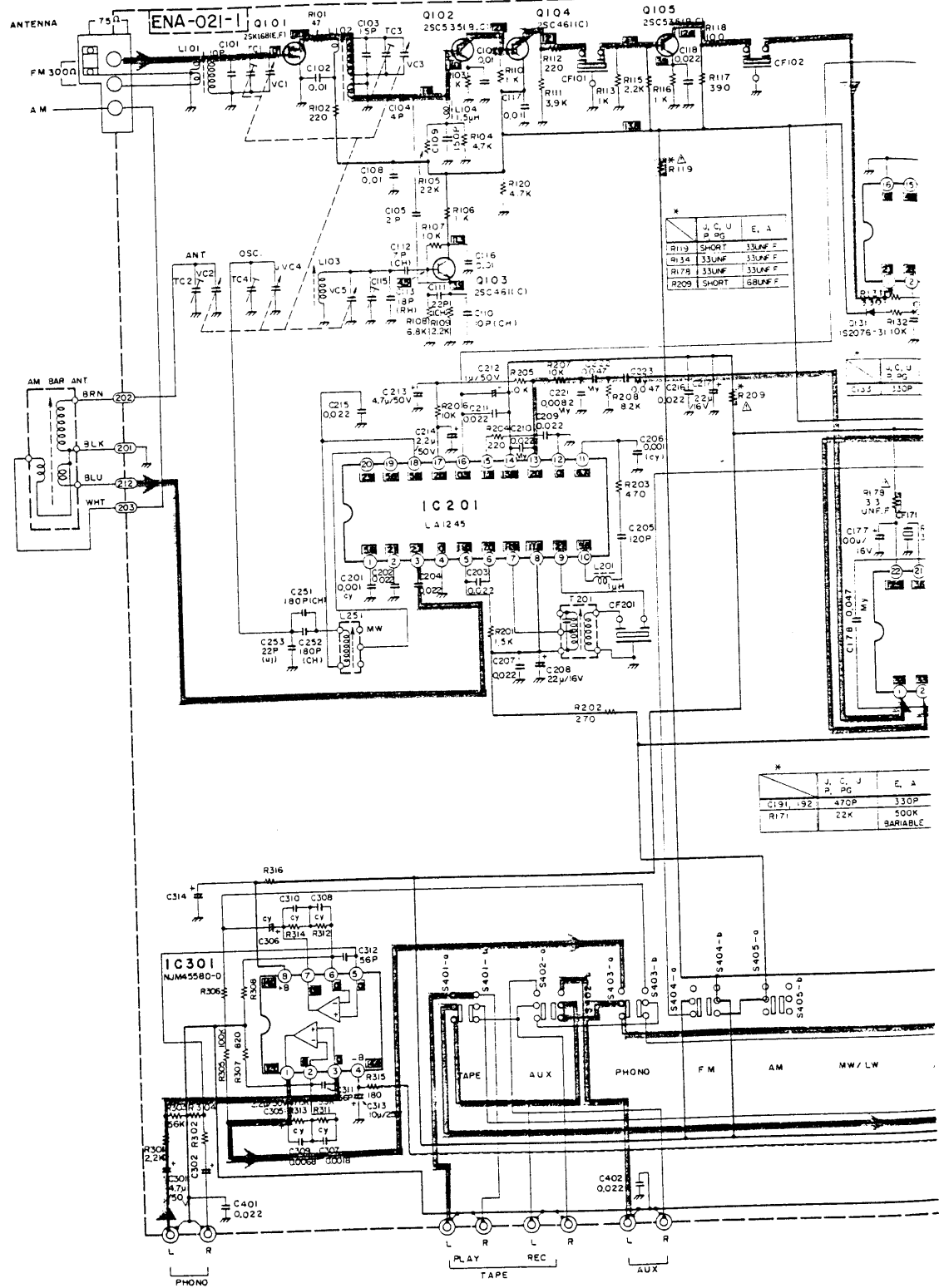



Notes:

1. shows DC voltage to the chassis with no signal input.
2. indicates positive B power supply.
3. indicates negative B power supply.
4. indicates signal path.

5. When replacing the parts in the darkened area () and those marked with Δ , be sure to use the designated parts to ensure safety.
6. This is the standard circuit diagram. The design and contents are subject to change without notice.

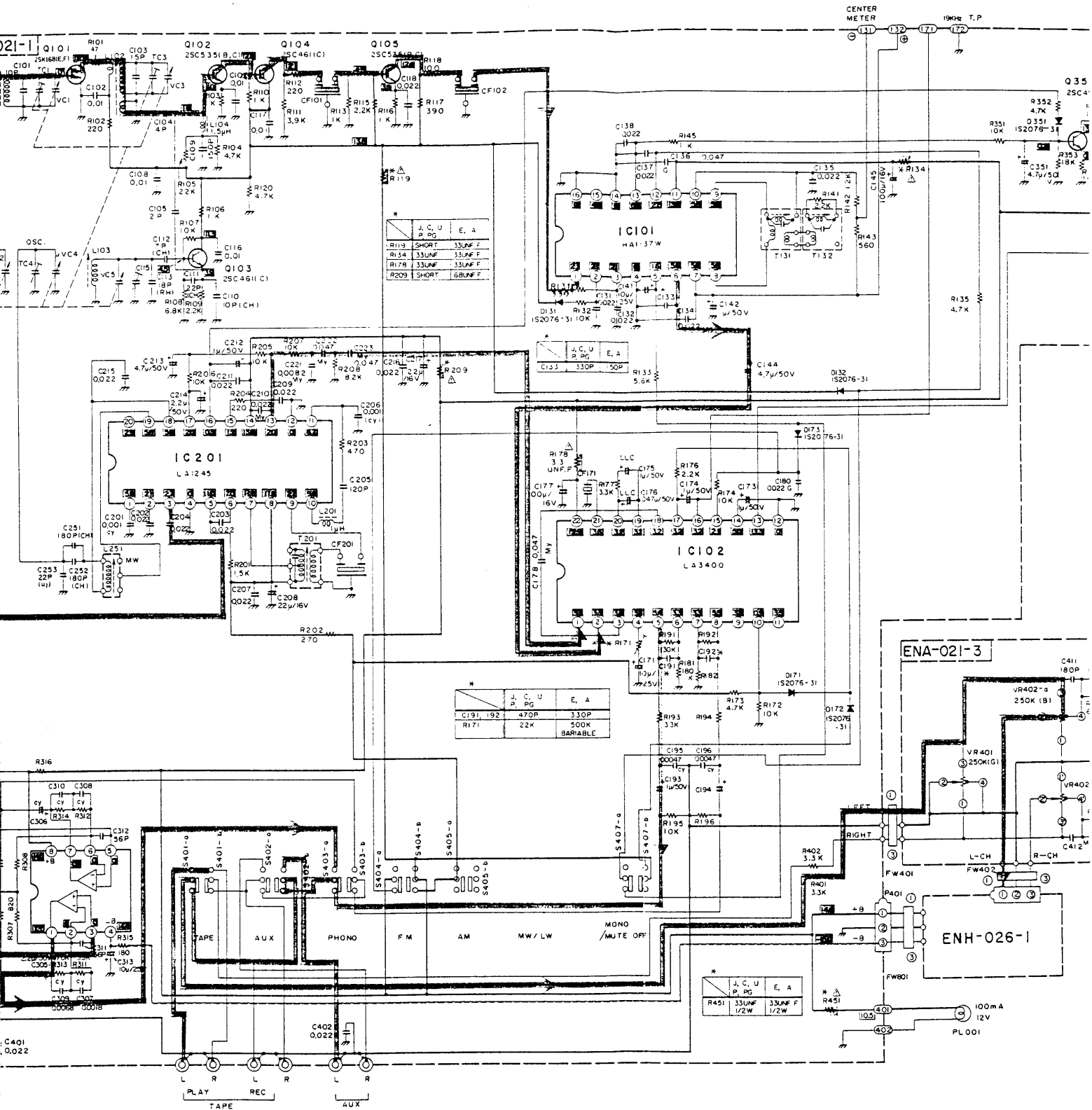
Schematic Diagram



- When replacing the parts in the darkned area () and those marked with Δ , be sure to use the designated parts to ensure safety.
- This is the standard circuit diagram. The design and contents are subject to change without notice.

no signal input.

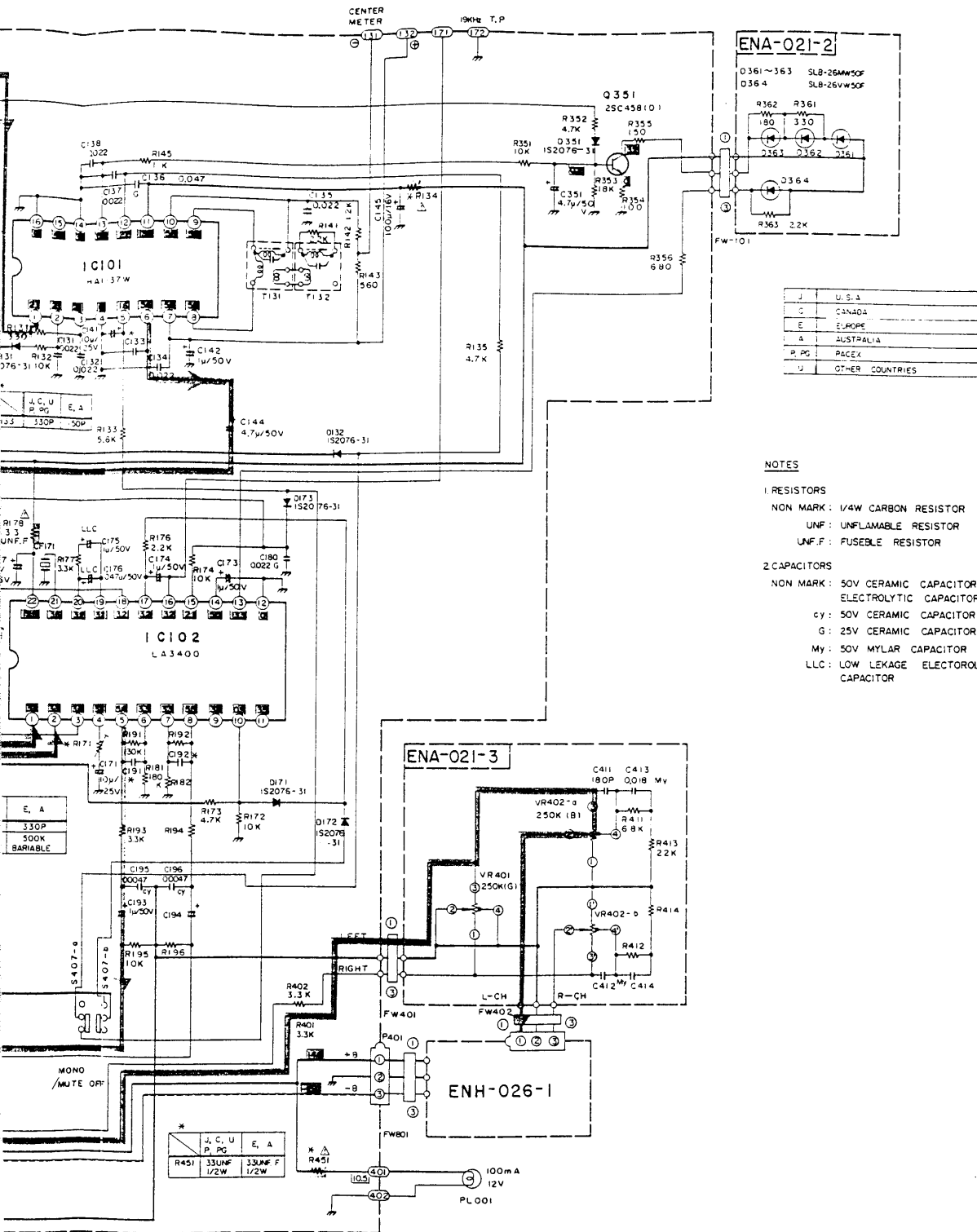

J	U.S.A
C	CANADA
E	EUROPE
A	AUSTRALIA
P, PS	PACEX
U	OTHER COUNTRIES

NOTES

1. RESISTORS
 NON MARK : 1/4W CARBON RESISTOR
 UNF : UNFLAMABLE RESISTOR
 UNF.F : FUSEBLE RESISTOR
2. CAPACITORS
 NON MARK : 50V CERAMIC CAPACITOR OR ELECTROLYTIC CAPACITOR
 cy : 50V CERAMIC CAPACITOR (B)
 G : 25V CERAMIC CAPACITOR (B)
 My : 50V MYLAR CAPACITOR
 LLC : LOW LEKAGE ELECTOROLYTIC CAPACITOR

and parts

without

5-(2) R-K100(G) Tuner Section (for West Germany only)

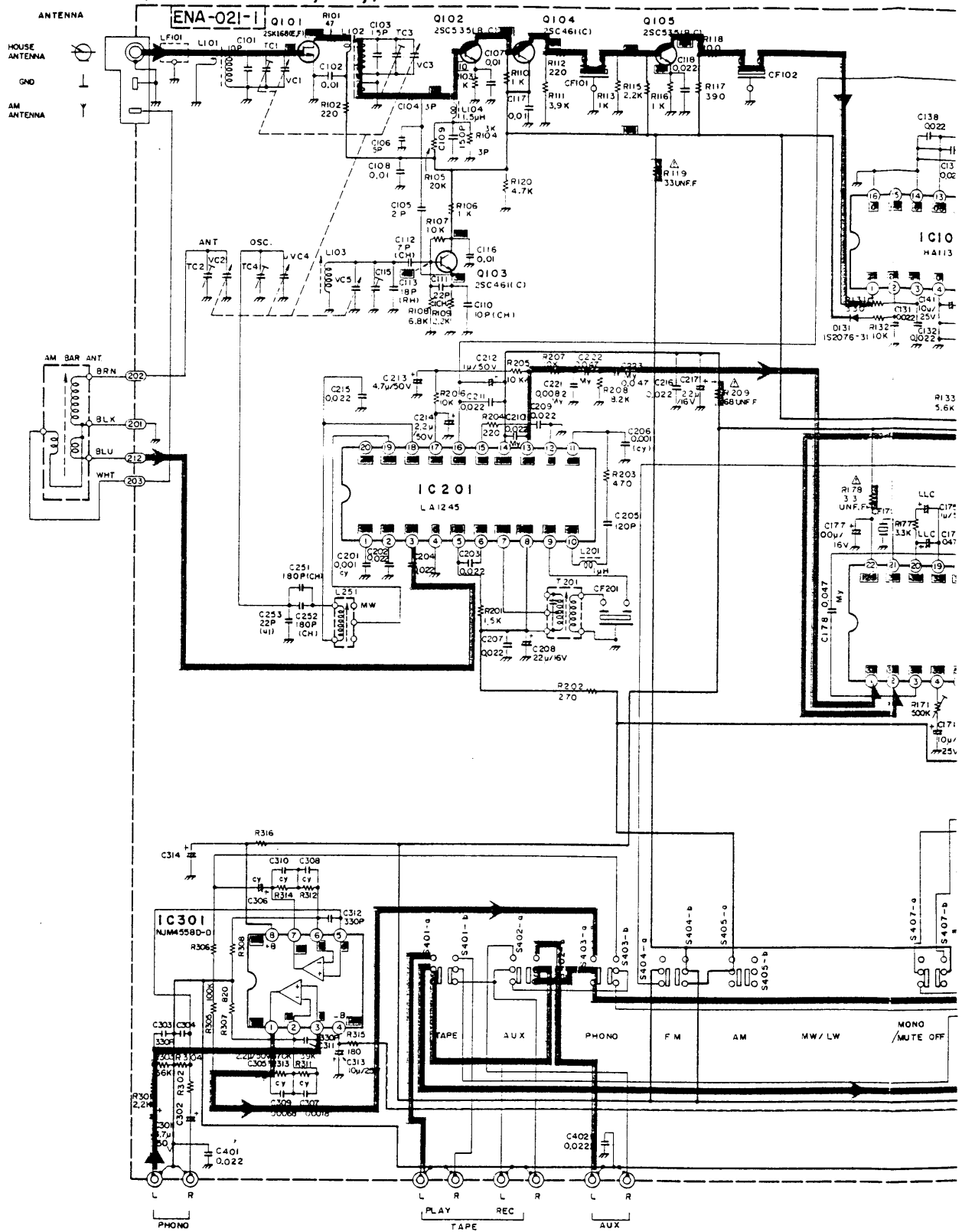

Notes:

1. shows DC voltage to the chassis with no signal input.
2. indicates positive B power supply.
3. indicates negative B power supply.
4. indicates signal path.

5. When replacing the parts in the darkened area () and those marked with , be sure to use the designated parts to ensure safety.
6. This is the standard circuit diagram.
The design and contents are subject to change without notice.

ly)

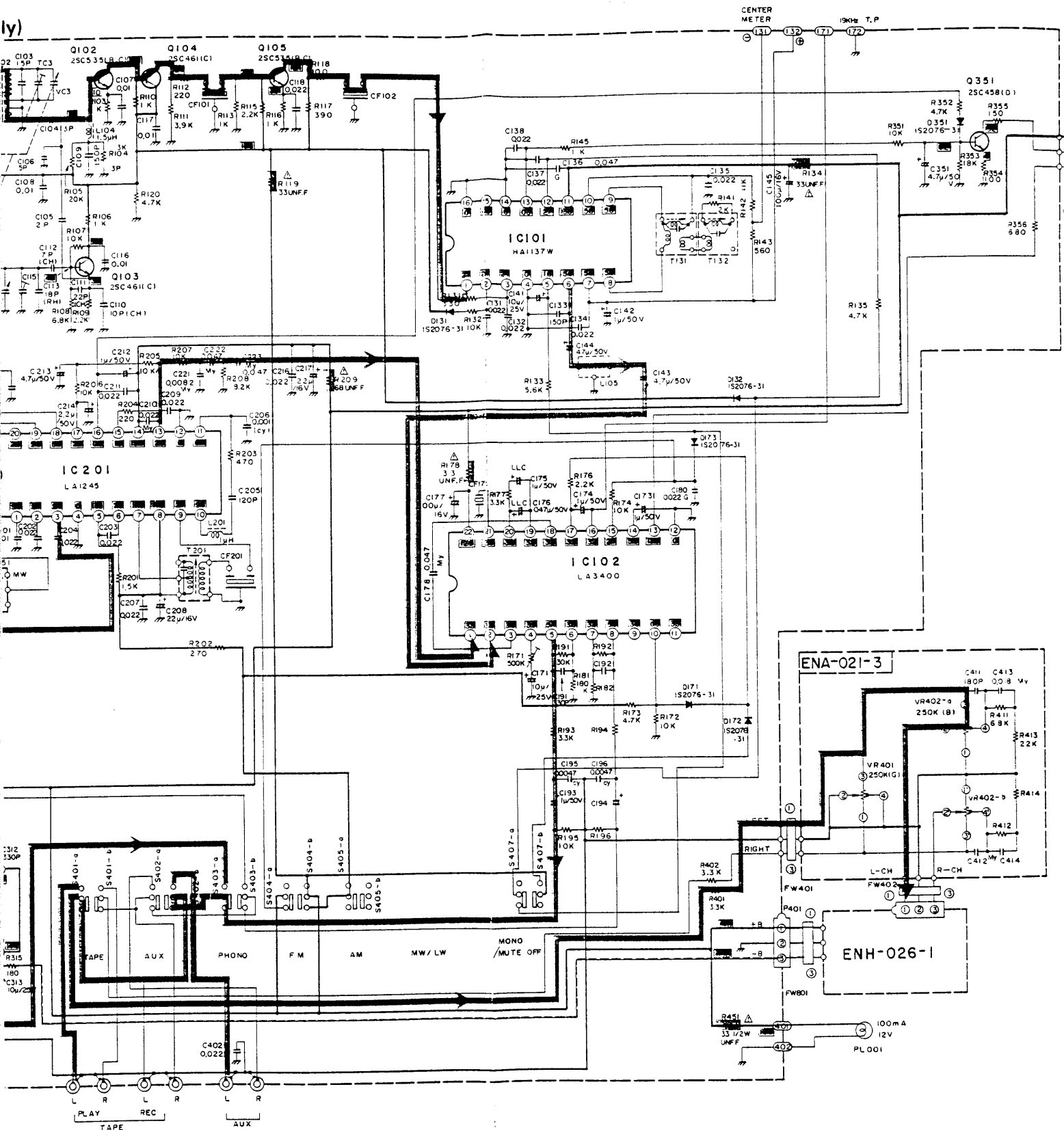

5. When replacing the parts in the darkened area () and those marked with Δ , be sure to use the designated parts to ensure safety.
6. This is the standard circuit diagram.
The design and contents are subject to change without notice.

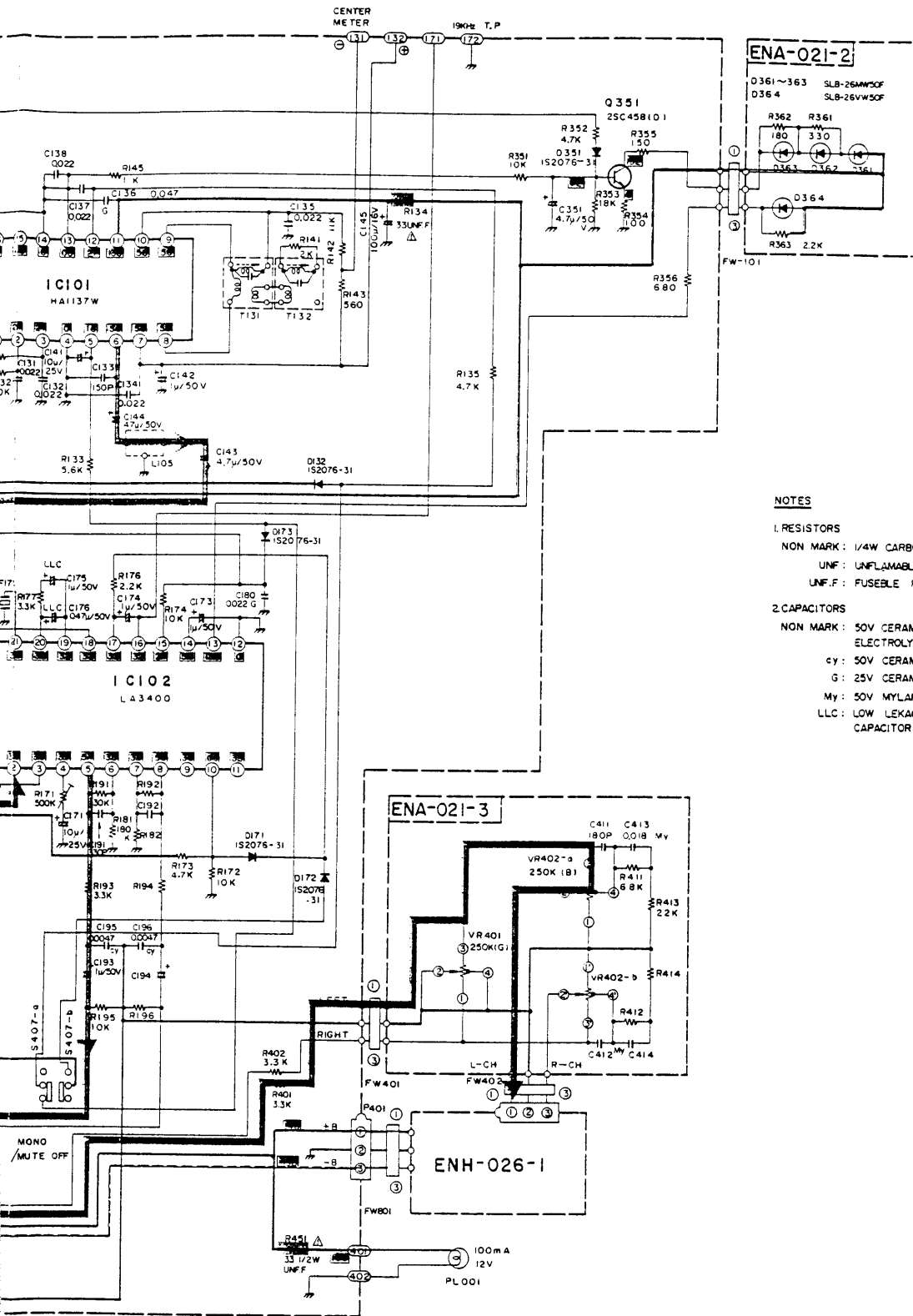

NOTES

1. RESISTORS

- NON MARK: 1/4W CARBON RESISTOR
- UNF: UNFLAMABLE RESISTOR
- UNF.F: FUSEBLE RESISTOR





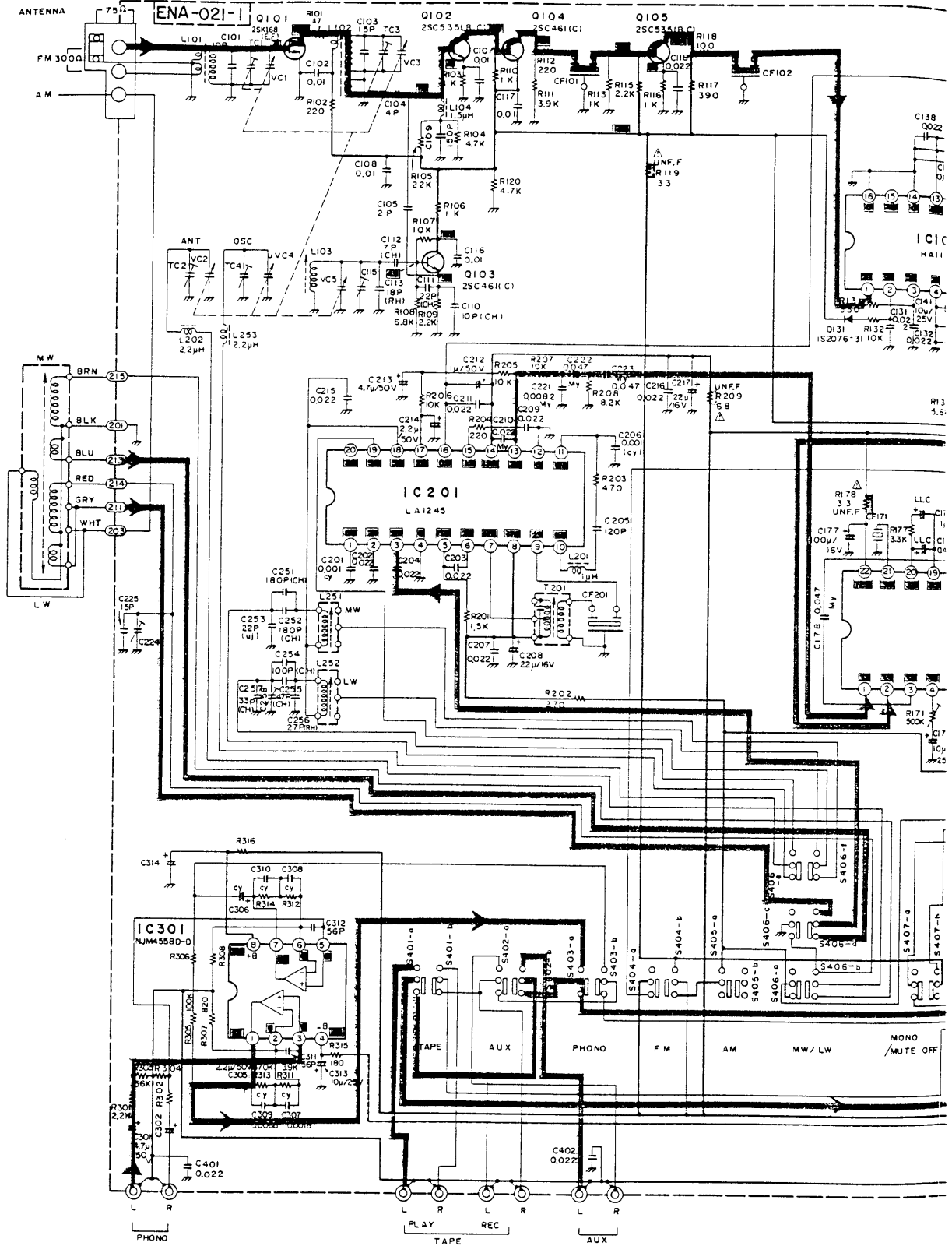

2. CAPACITORS

- NON MARK: 50V CERAMIC CAPACITOR OR ELECTROLYTIC CAPACITOR
- cy: 50V CERAMIC CAPACITOR (B)
- G: 25V CERAMIC CAPACITOR (B)
- My: 50V MYLAR CAPACITOR
- LLC: LOW LEKAGE ELECTROLYTIC CAPACITOR

5-(3) R-K100L Tuner Section



Notes:

1.  shows DC voltage to the chassis with no signal input.
2.  indicates positive B power supply.
3.  indicates negative B power supply.
4.  indicates signal path.
5. When replacing the parts in the darkened area () and those marked with  , be sure to use the designated parts to ensure safety.
6. This is the standard circuit diagram.
The design and contents are subject to change without notice.

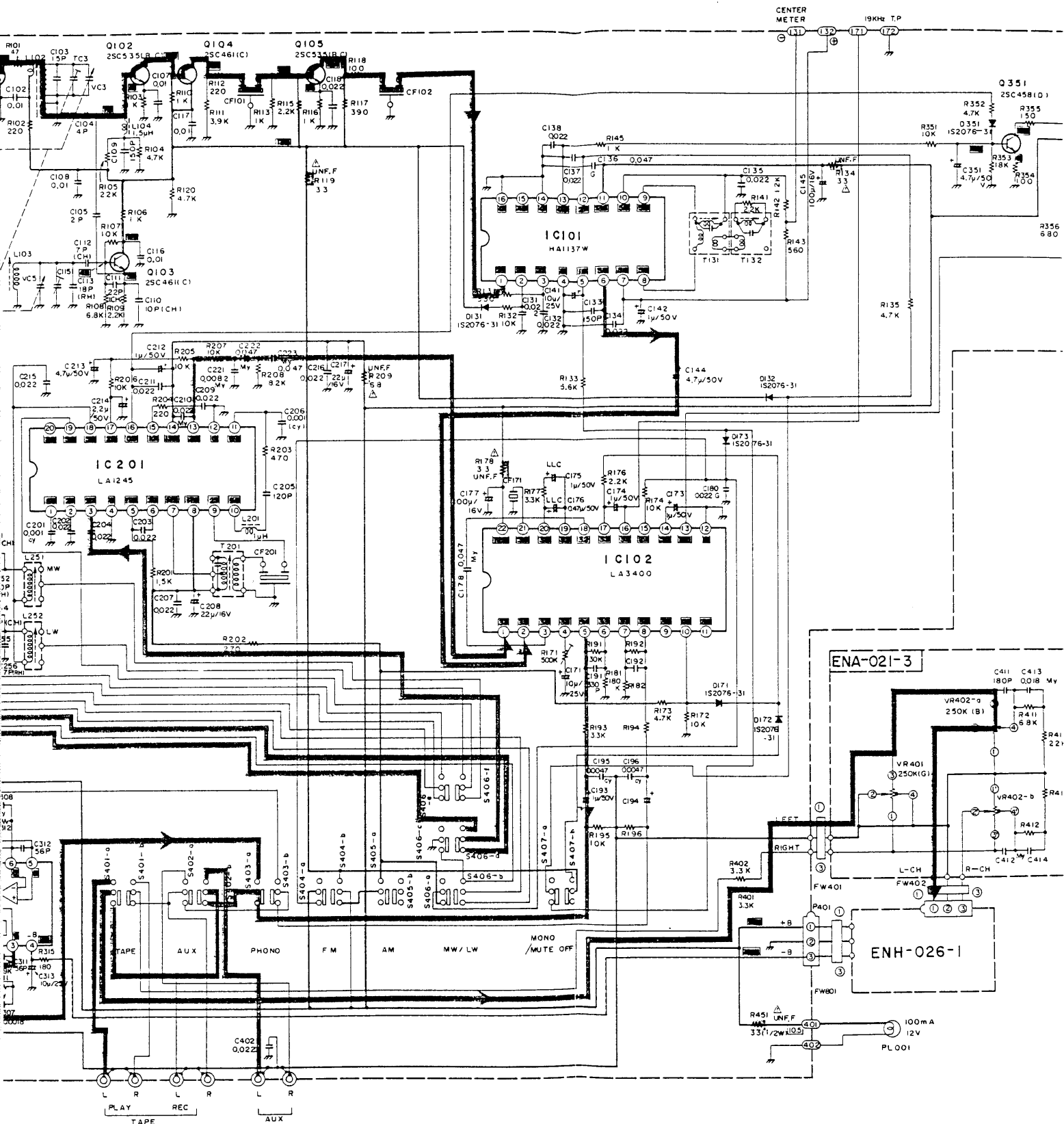

- When replacing the parts in the darkened area () and those marked with Δ , be sure to use the designated parts to ensure safety.
- This is the standard circuit diagram. The design and contents are subject to change without notice.

al input.

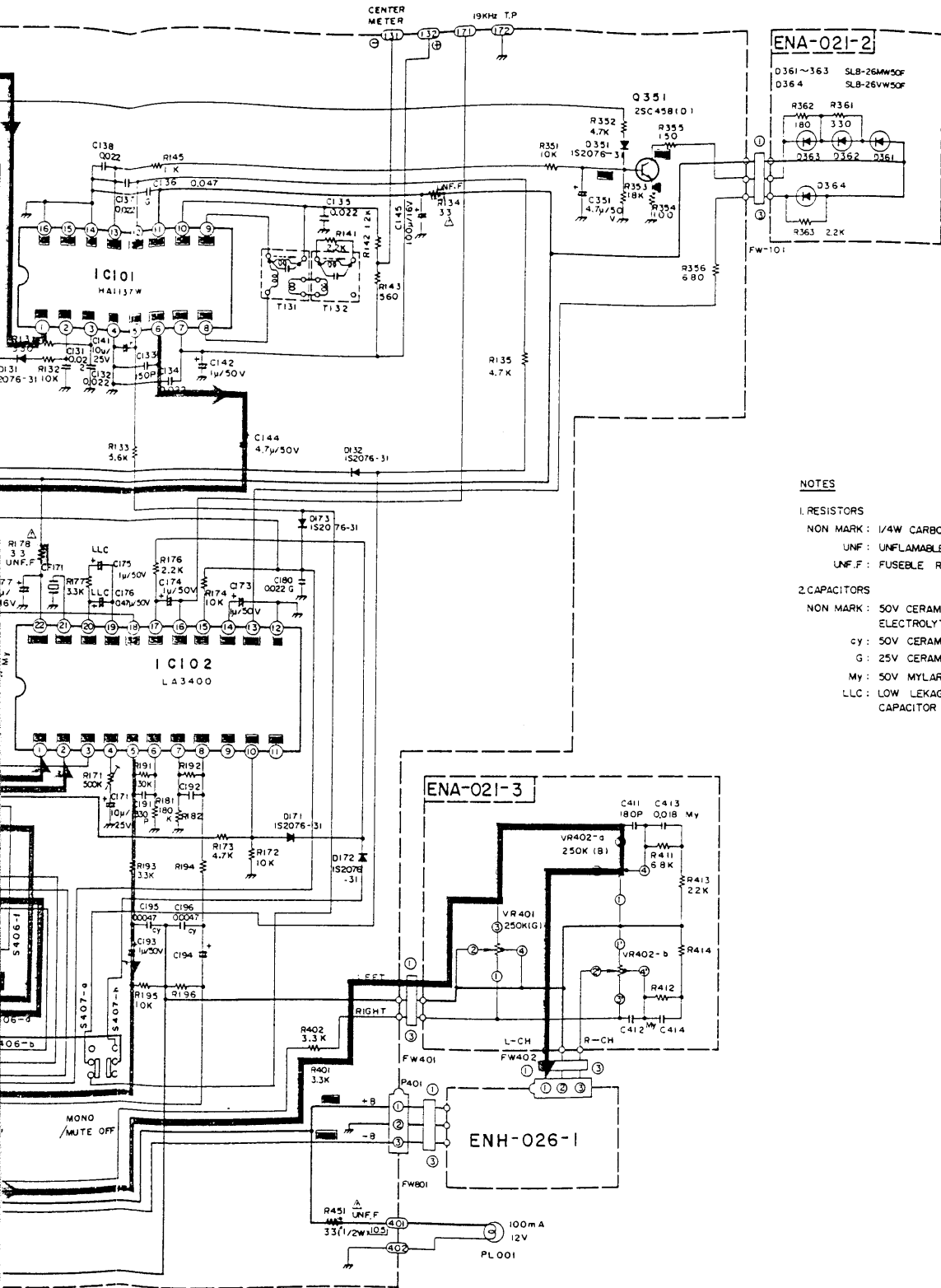

NOTES

- 1. RESISTORS
 - NON MARK: 1/4W CARBON RESISTOR
 - UNF: UNFLAMMABLE RESISTOR
 - UNF.F: FUSEBLE RESISTOR
- 2. CAPACITORS
 - NON MARK: 50V CERAMIC CAPACITOR OR ELECTROLYTIC CAPACITOR
 - cy: 50V CERAMIC CAPACITOR (B)
 - G: 25V CERAMIC CAPACITOR (B)
 - My: 50V MYLAR CAPACITOR
 - LLC: LOW LEKAGE ELECTOROLYTIC CAPACITOR

) and
ated parts

without

5-(4) R-K100/R-K100L Amplifier Section

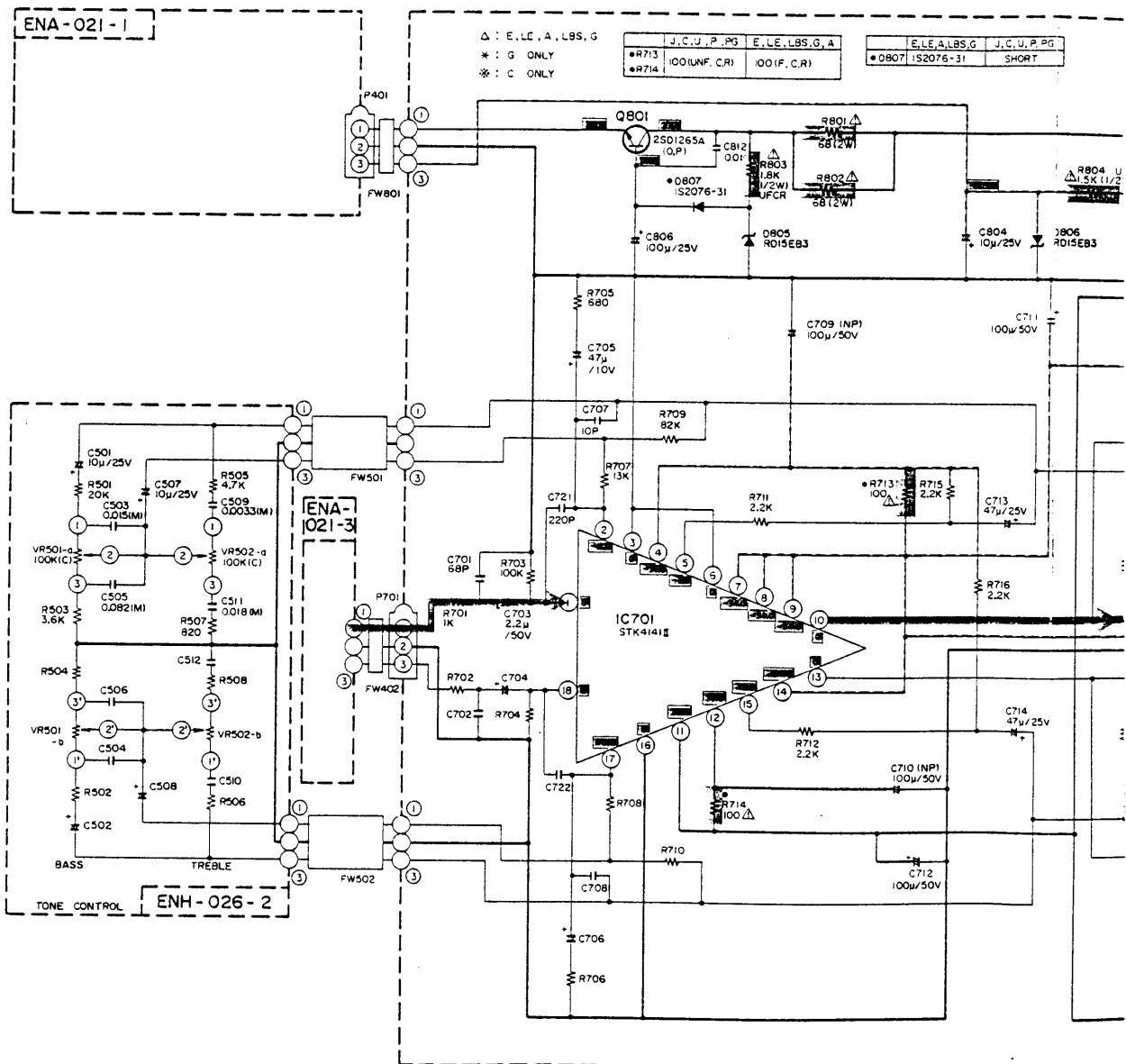
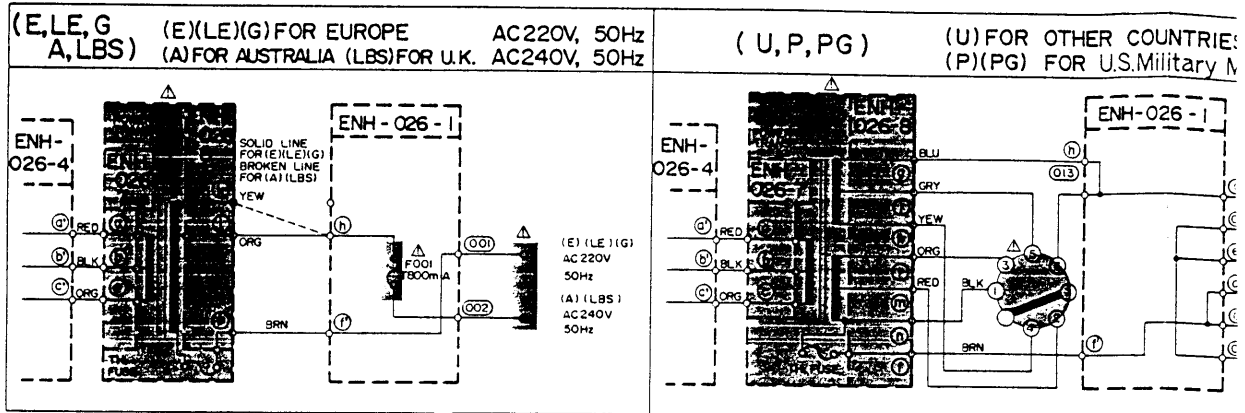

Notes:

1. shows DC voltage to the chassis with no signal input.
2. indicates positive B power supply.
3. indicates negative B power supply.
4. indicates signal path.

5. When replacing the parts in the darkened area () and those marked with Δ , be sure to use the designated parts to ensure safety.
6. This is the standard circuit diagram. The design and contents are subject to change without notice.

AC220V, 50Hz
AC240V, 50Hz

(U, P, PG)

(U) FOR OTHER COUNTRIES
(P)(PG) FOR U.S. Military Market

(J, C)

(J) FOR U.S.A.
(C) FOR CANADA

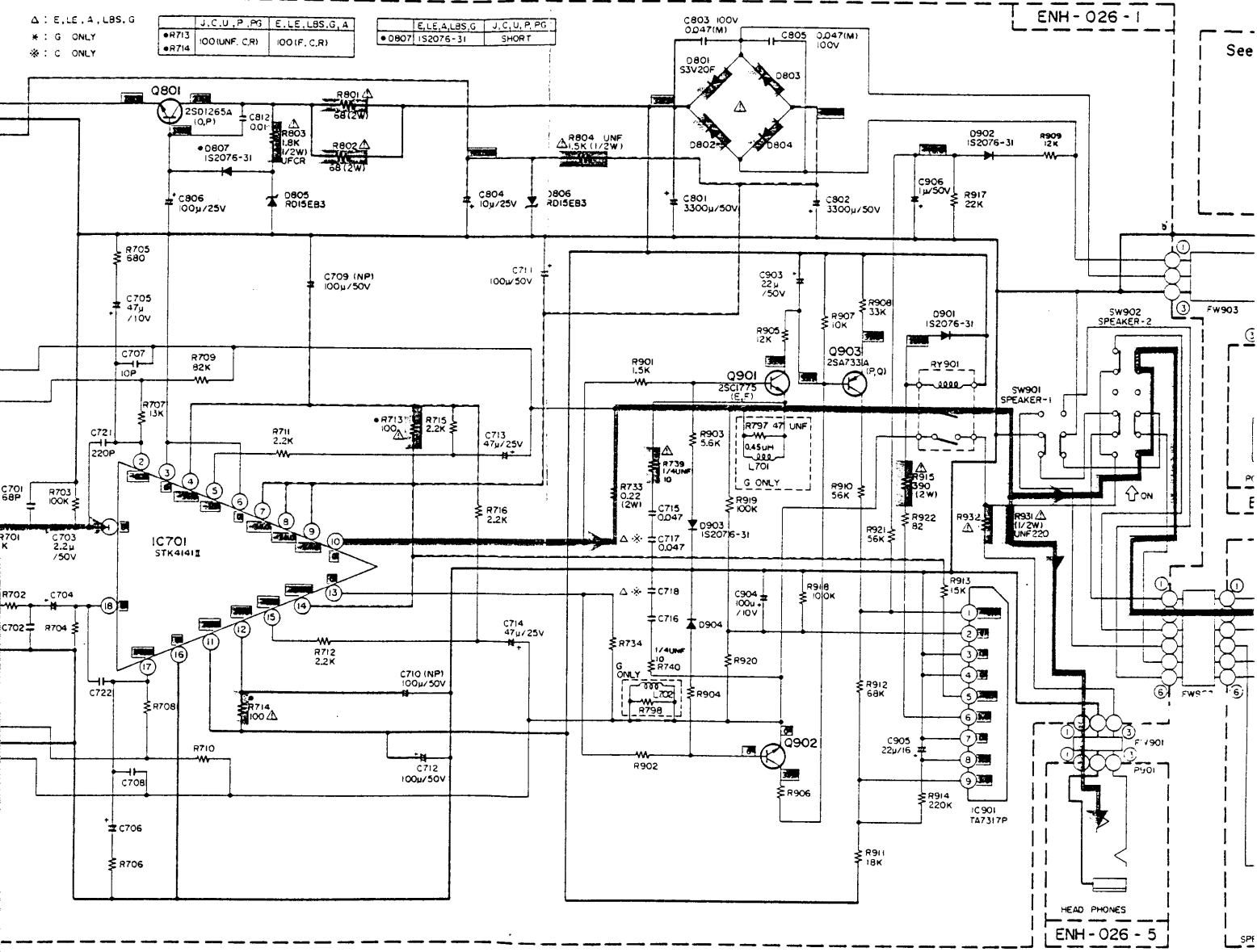
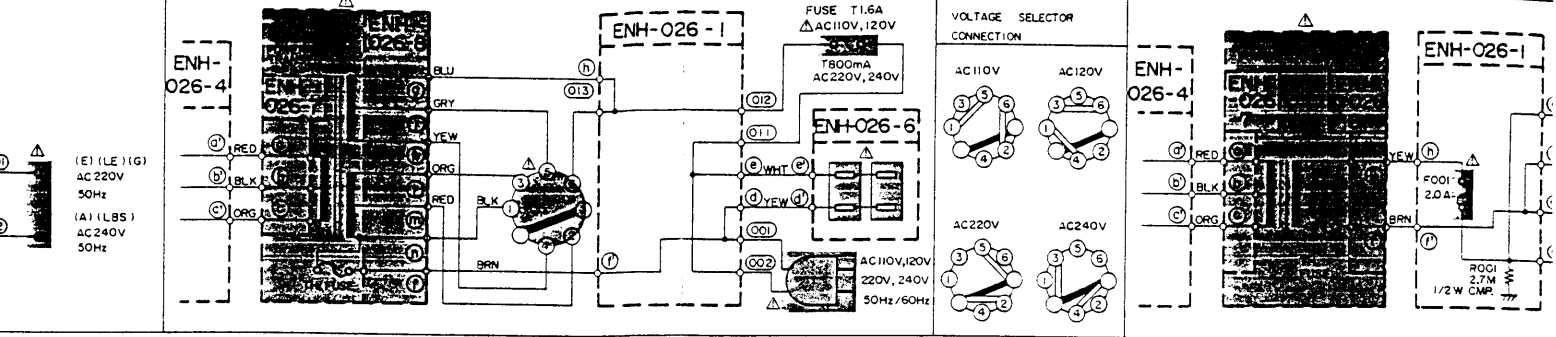

- 5. When replacing the parts in the darkened area () and those marked with Δ, be sure to use the designated parts to ensure safety.
- 3. This is the standard circuit diagram.
The design and contents are subject to change without notice.

COUNTRIES
Military Market

(J, C) (J) FOR U.S.A.
(C) FOR CANADA

AC120V, 60Hz

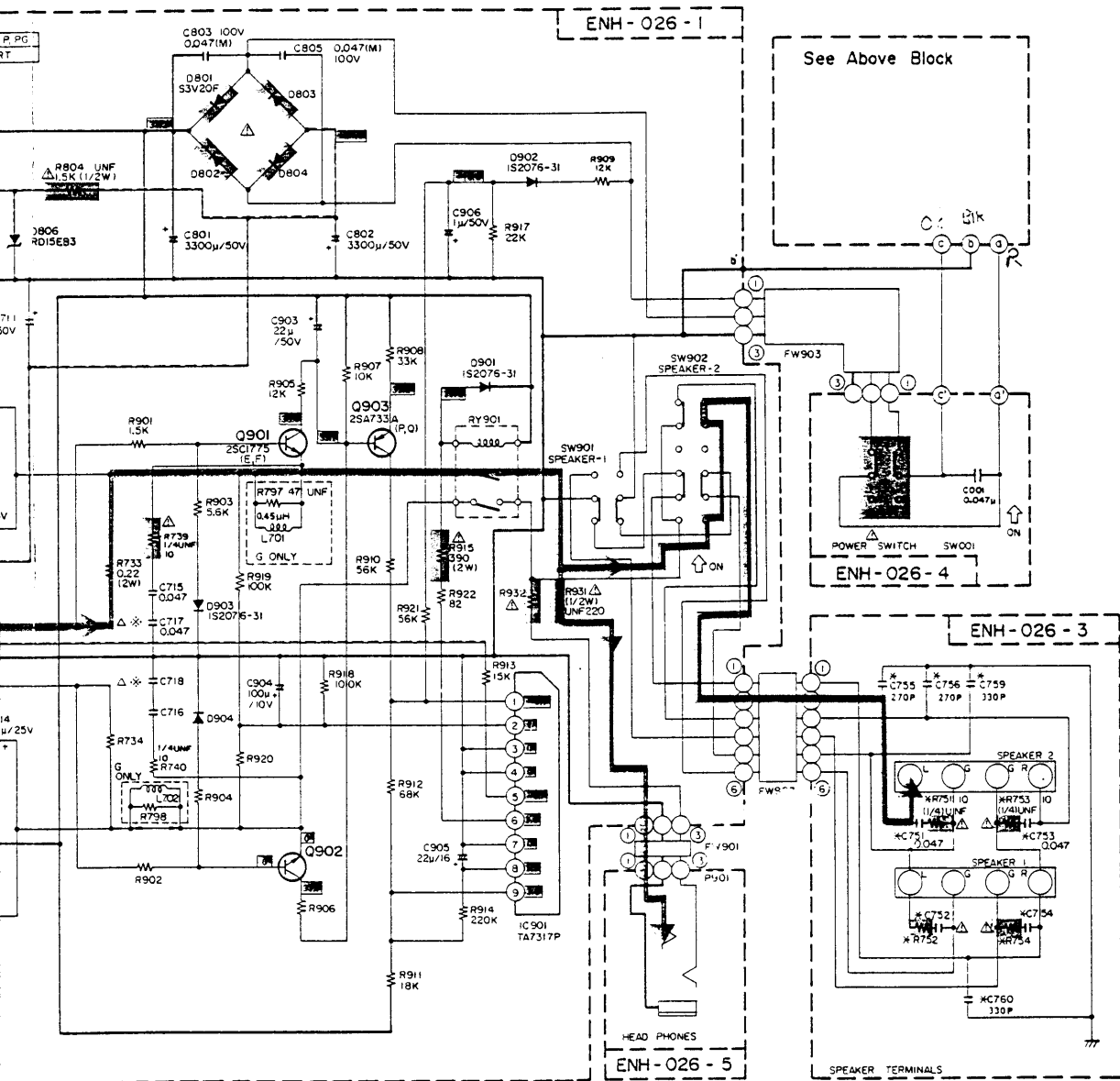
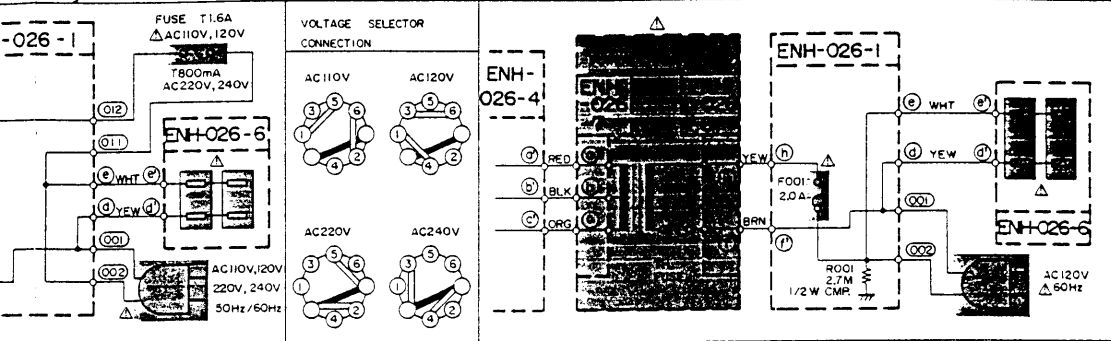

6. Servicing Method For AWG #20 Wires With Clamping Terminals

(1) Application objective \Rightarrow Confirmation of safety
Used to prevent breakage/disconnection troubles of primary and secondary wires within PC boards (or between PC boards). Even when wire breakage/disconnection has actually occurred, a safe air-gap distance between the primary wire and the secondary wire/possibly contacting metal surface can be maintained because the terminal retains the wire sheathing.

(2) Type of wire used

- ① 1015 AWG- #20 (single-coated)
- ② 1672 AWG- #20 (double-coated)

(3) Servicing precautions

- ① The structural design of this terminal causes its catch to hook onto the PC board, preventing the wire from being easily pulled out. As shown in the figure, use cutting pliers or a similar tool to cut off the ends of the terminal and wire; then remove the remaining terminal clip by melting the soldering.

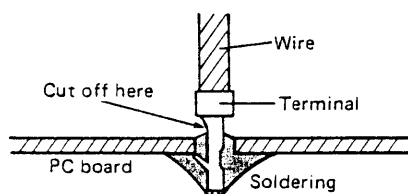

- ② Prior to soldering the wire onto the PC board, confirm safety by pressure-fitting the terminal to the wire by observing the following procedures.

1. Strip off the wire 5 ~ 6 mm from its end.

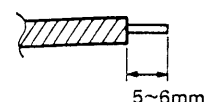

- 2. Insert the wire until its sheathing contacts section "A" of the terminal and pressure-fit the terminal clamp at three sections of (a), (b), and (c) (section (c) is especially important to assure safety. Exercise particular care to achieve secure clamping).

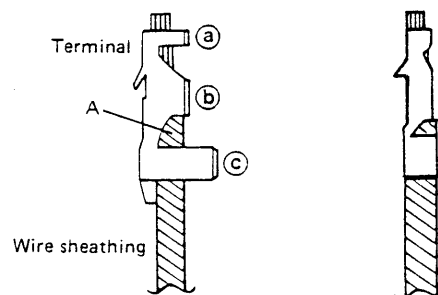

- ③ Part No., and name

Part No. : 5298T
Name : CRIMP PIN

